

**RAMPAGE IV  
FORMULA**

**ASUS®**

**Motherboard**

**Copyright © 2012 ASUSTeK COMPUTER INC. All Rights Reserved.**

No part of this manual, including the products and software described in it, may be reproduced, transmitted, transcribed, stored in a retrieval system, or translated into any language in any form or by any means, except documentation kept by the purchaser for backup purposes, without the express written permission of ASUSTeK COMPUTER INC. ("ASUS").

Product warranty or service will not be extended if: (1) the product is repaired, modified or altered, unless such repair, modification of alteration is authorized in writing by ASUS; or (2) the serial number of the product is defaced or missing.

ASUS PROVIDES THIS MANUAL "AS IS" WITHOUT WARRANTY OF ANY KIND, EITHER EXPRESS OR IMPLIED, INCLUDING BUT NOT LIMITED TO THE IMPLIED WARRANTIES OR CONDITIONS OF MERCHANTABILITY OR FITNESS FOR A PARTICULAR PURPOSE. IN NO EVENT SHALL ASUS, ITS DIRECTORS, OFFICERS, EMPLOYEES OR AGENTS BE LIABLE FOR ANY INDIRECT, SPECIAL, INCIDENTAL, OR CONSEQUENTIAL DAMAGES (INCLUDING DAMAGES FOR LOSS OF PROFITS, LOSS OF BUSINESS, LOSS OF USE OR DATA, INTERRUPTION OF BUSINESS AND THE LIKE), EVEN IF ASUS HAS BEEN ADVISED OF THE POSSIBILITY OF SUCH DAMAGES ARISING FROM ANY DEFECT OR ERROR IN THIS MANUAL OR PRODUCT.

SPECIFICATIONS AND INFORMATION CONTAINED IN THIS MANUAL ARE FURNISHED FOR INFORMATIONAL USE ONLY, AND ARE SUBJECT TO CHANGE AT ANY TIME WITHOUT NOTICE, AND SHOULD NOT BE CONSTRUED AS A COMMITMENT BY ASUS. ASUS ASSUMES NO RESPONSIBILITY OR LIABILITY FOR ANY ERRORS OR INACCURACIES THAT MAY APPEAR IN THIS MANUAL, INCLUDING THE PRODUCTS AND SOFTWARE DESCRIBED IN IT.

Products and corporate names appearing in this manual may or may not be registered trademarks or copyrights of their respective companies, and are used only for identification or explanation and to the owners' benefit, without intent to infringe.

**Offer to Provide Source Code of Certain Software**

This product may contain copyrighted software that is licensed under the General Public License ("GPL") and under the Lesser General Public License Version ("LGPL"). The GPL and LGPL licensed code in this product is distributed without any warranty. Copies of these licenses are included in this product.

You may obtain the complete corresponding source code (as defined in the GPL) for the GPL Software, and/or the complete corresponding source code of the LGPL Software (with the complete machine-readable "work that uses the Library") for a period of three years after our last shipment of the product including the GPL Software and/or LGPL Software, which will be no earlier than December 1, 2011, either (1) for free by downloading it from <http://support.asus.com/download>;

or

(2) for the cost of reproduction and shipment, which is dependent on the preferred carrier and the location where you want to have it shipped to, by sending a request to:

ASUSTeK Computer Inc.  
Legal Compliance Dept.  
15 Li Te Rd.,  
Beitou, Taipei 112  
Taiwan

In your request please provide the name, model number and version, as stated in the About Box of the product for which you wish to obtain the corresponding source code and your contact details so that we can coordinate the terms and cost of shipment with you.

The source code will be distributed WITHOUT ANY WARRANTY and licensed under the same license as the corresponding binary/object code.

This offer is valid to anyone in receipt of this information.

ASUSTeK is eager to duly provide complete source code as required under various Free Open Source Software licenses. If however you encounter any problems in obtaining the full corresponding source code we would be much obliged if you give us a notification to the email address [gpl@asus.com](mailto:gpl@asus.com), stating the product and describing the problem (please do NOT send large attachments such as source code archives etc to this email address).

# Contents

Notices .....	vi
Safety information.....	x
About this guide.....	xii
RAMPAGE IV FORMULA specifications summary.....	xiv

## Chapter 1: Product introduction

1.1	Welcome! .....	1-1
1.2	Package contents.....	1-1
1.3	Special features.....	1-2
1.3.1	Product highlights.....	1-2
1.3.2	ROG Exclusive Features.....	1-3
1.3.3	Sound with Clarity .....	1-5
1.3.4	Future Transfer Technology .....	1-5
1.3.5	Software Bundled.....	1-6

## Chapter 2: Hardware information

2.1	Before you proceed .....	2-1
2.2	Motherboard overview.....	2-2
2.2.1	Motherboard layout.....	2-2
2.2.2	Central Processing Unit (CPU) .....	2-4
2.2.3	System memory .....	2-5
2.2.4	Expansion slots.....	2-12
2.2.5	Onboard switches .....	2-14
2.2.6	Onboard LEDs .....	2-18
2.2.7	Jumper .....	2-26
2.2.8	Internal connectors.....	2-27
2.3	Building your computer system .....	2-38
2.3.1	Additional tools and components to build a PC system .....	2-38
2.3.2	CPU installation.....	2-39
2.3.3	CPU heatsink and fan assembly installation .....	2-41
2.3.4	DIMM installation.....	2-43
2.3.5	Motherboard installation.....	2-44
2.3.6	ATX Power connection.....	2-46
2.3.7	SATA device connection.....	2-47
2.3.8	Front I/O Connector .....	2-48
2.3.9	Expansion Card installation.....	2-49
2.3.10	Rear panel connection .....	2-50
2.3.11	Audio I/O connections.....	2-52
2.4	Starting up for the first time.....	2-54

# Contents

2.5	Turning off the computer.....	2-54
-----	-------------------------------	------

## Chapter 3: BIOS setup

3.1	Knowing BIOS.....	3-1
3.2	BIOS setup program.....	3-1
3.2.1	Advanced Mode.....	3-2
3.2.2	EZ Mode.....	3-4
3.3	Extreme Tweaker menu.....	3-5
3.4	Main menu.....	3-18
3.4.1	System Language [English].....	3-18
3.4.2	System Date [Day xx/xx/xxxx].....	3-18
3.4.3	System Time [xx:xx:xx].....	3-18
3.4.4	Security.....	3-19
3.5	Advanced menu.....	3-21
3.5.1	CPU Configuration.....	3-22
3.5.2	System Agent Configuration.....	3-24
3.5.3	PCH Configuration.....	3-24
3.5.4	SATA Configuration.....	3-25
3.5.5	USB Configuration.....	3-26
3.5.6	Onboard Devices Configuraton.....	3-27
3.5.7	APM.....	3-29
3.6	Monitor menu.....	3-30
3.7	Boot menu.....	3-34
3.8	Tools menu.....	3-36
3.8.1	ASUS EZ Flash 2 Utility.....	3-36
3.8.2	ASUS SPD Information.....	3-37
3.8.3	ASUS O.C. Profile.....	3-38
3.8.4	BIOS FlashBack.....	3-39
3.8.5	GO Button File.....	3-40
3.9	Exit menu.....	3-41
3.10	Updating BIOS.....	3-42
3.10.1	ASUS Update utility.....	3-42
3.10.2	ASUS EZ Flash 2 Utility.....	3-46
3.10.3	ASUS CrashFree BIOS 3 utility.....	3-47
3.10.4	ASUS BIOS Updater.....	3-48
3.10.5	USB BIOS Flashback.....	3-51

## Chapter 4: Software support

4.1	Installing an operating system.....	4-1
4.2	Support DVD information.....	4-1



# Contents

4.2.1	Running the support DVD .....	4-1
4.2.2	Obtaining the software manuals .....	4-2
<b>4.3</b>	<b>Software information .....</b>	<b>4-3</b>
4.3.1	AI Suite II .....	4-3
4.3.2	TurboV EVO .....	4-4
4.3.3	DIGI+ Power Control .....	4-8
4.3.4	EPU .....	4-10
4.3.5	FAN Xpert .....	4-11
4.3.6	Sensor Recorder .....	4-12
4.3.7	Probe II .....	4-13
4.3.8	USB 3.0 Boost .....	4-14
4.3.9	Ai Charger+ .....	4-15
4.3.10	ASUS Update .....	4-16
4.3.11	MyLogo2 .....	4-17
4.3.12	ROG Connect .....	4-19
4.3.13	Audio configurations .....	4-22
4.3.14	Sound Blaster X-Fi MB 2 .....	4-23
<b>4.4</b>	<b>RAID configurations .....</b>	<b>4-26</b>
4.4.1	RAID definitions .....	4-26
4.4.2	Installing Serial ATA hard disks .....	4-27
4.4.3	Setting the RAID item in BIOS .....	4-27
4.4.4	Intel® Rapid Storage Technology Option ROM utility .....	4-27
<b>4.5</b>	<b>Creating a RAID driver disk .....</b>	<b>4-31</b>
4.5.1	Creating a RAID driver disk without entering the OS .....	4-31
4.5.2	Creating a RAID driver disk in Windows® .....	4-31
4.5.3	Installing the RAID driver during Windows® OS installation .....	4-32
4.5.4	Using a USB floppy disk drive .....	4-33
 <b>Chapter 5: Multiple GPU technology support</b>		
<b>5.1</b>	<b>AMD® CrossFireX™ technology .....</b>	<b>5-1</b>
5.1.1	Requirements .....	5-1
5.1.2	Before you begin .....	5-1
5.1.3	Installing two CrossFireX™ graphics cards .....	5-2
5.1.4	Installing the device drivers .....	5-3
5.1.5	Enabling the AMD® CrossFireX™ technology .....	5-3
<b>5.2</b>	<b>NVIDIA® SLI™ technology .....</b>	<b>5-4</b>
5.2.1	Requirements .....	5-4
5.2.2	Installing two SLI-ready graphics cards .....	5-4
5.2.3	Installing the device drivers .....	5-5
5.2.4	Enabling the NVIDIA® SLI™ technology .....	5-5

# Notices

## Federal Communications Commission Statement

This device complies with Part 15 of the FCC Rules. Operation is subject to the following two conditions:

- This device may not cause harmful interference, and
- This device must accept any interference received including interference that may cause undesired operation.

This equipment has been tested and found to comply with the limits for a Class B digital device, pursuant to Part 15 of the FCC Rules. These limits are designed to provide reasonable protection against harmful interference in a residential installation. This equipment generates, uses and can radiate radio frequency energy and, if not installed and used in accordance with manufacturer's instructions, may cause harmful interference to radio communications. However, there is no guarantee that interference will not occur in a particular installation. If this equipment does cause harmful interference to radio or television reception, which can be determined by turning the equipment off and on, the user is encouraged to try to correct the interference by one or more of the following measures:

- Reorient or relocate the receiving antenna.
- Increase the separation between the equipment and receiver.
- Connect the equipment to an outlet on a circuit different from that to which the receiver is connected.
- Consult the dealer or an experienced radio/TV technician for help.



---

The use of shielded cables for connection of the monitor to the graphics card is required to assure compliance with FCC regulations. Changes or modifications to this unit not expressly approved by the party responsible for compliance could void the user's authority to operate this equipment.

---

## FCC Radio Frequency (RF) Exposure Caution Statement



---

Any changes or modifications not expressly approved by the party responsible for compliance could void the user's authority to operate this equipment. "The manufacture declares that this device is limited to Channels 1 through 11 in the 2.4GHz frequency by specified firmware controlled in the USA."

---

This equipment complies with FCC radiation exposure limits set forth for an uncontrolled environment. To maintain compliance with FCC RF exposure compliance requirements, please avoid direct contact to the transmitting antenna during transmitting. End users must follow the specific operating instructions for satisfying RF exposure compliance.

## RF exposure warning

This equipment must be installed and operated in accordance with provided instructions and the antenna(s) used for this transmitter must be installed to provide a separation distance of at least 20 cm from all persons and must not be co-located or operating in conjunction with any other antenna or transmitter. End-users and installers must be provide with antenna installation instructions and transmitter operating conditions for satisfying RF exposure compliance.

## Declaration of Conformity (R&TTE directive 1999/5/EC)

The following items were completed and are considered relevant and sufficient:

- Essential requirements as in [Article 3]
- Protection requirements for health and safety as in [Article 3.1a]
- Testing for electric safety according to [EN 60950]
- Protection requirements for electromagnetic compatibility in [Article 3.1b]
- Testing for electromagnetic compatibility in [EN 301 489-1] & [EN 301 489-17]
- Effective use of the radio spectrum as in [Article 3.2]
- Radio test suites according to [EN 300 328-2]

### CE Mark Warning



### CE marking for devices without wireless LAN/Bluetooth

The shipped version of this device complies with the requirements of the EEC directives 2004/108/EC “Electromagnetic compatibility” and 2006/95/EC “Low voltage directive”.



### CE marking for devices with wireless LAN/ Bluetooth

This equipment complies with the requirements of Directive 1999/5/EC of the European Parliament and Commission from 9 March, 1999 governing Radio and Telecommunications Equipment and mutual recognition of conformity.

## Wireless Operation Channel for Different Domains

N. America	2.412-2.462 GHz	Ch01 through CH11
Japan	2.412-2.484 GHz	Ch01 through Ch14
Europe ETSI	2.412-2.472 GHz	Ch01 through Ch13

## France Restricted Wireless Frequency Bands

Some areas of France have a restricted frequency band. The worst case maximum authorized power indoors are:

- 10mW for the entire 2.4 GHz band (2400 MHz–2483.5 MHz)
- 100mW for frequencies between 2446.5 MHz and 2483.5 MHz



---

Channels 10 through 13 inclusive operate in the band 2446.6 MHz to 2483.5 MHz.

---

There are few possibilities for outdoor use: On private property or on the private property of public persons, use is subject to a preliminary authorization procedure by the Ministry of Defense, with maximum authorized power of 100mW in the 2446.5–2483.5 MHz band. Use outdoors on public property is not permitted.

In the departments listed below, for the entire 2.4 GHz band:

- Maximum authorized power indoors is 100mW
- Maximum authorized power outdoors is 10mW

Departments in which the use of the 2400–2483.5 MHz band is permitted with an EIRP of less than 100mW indoors and less than 10mW outdoors:

01 Ain	02 Aisne	03 Allier	05 Hautes Alpes
08 Ardennes	09 Ariège	11 Aude	12 Aveyron
16 Charente	24 Dordogne	25 Doubs	26 Drôme
32 Gers	36 Indre	37 Indre et Loire	41 Loir et Cher
45 Loiret	50 Manche	55 Meuse	58 Nièvre
59 Nord	60 Oise	61 Orne	63 Puy du Dôme
64 Pyrénées Atlantique		66 Pyrénées Orientales	
67 Bas Rhin	68 Haut Rhin	70 Haute Saône	71 Saône et Loire
75 Paris	82 Tarn et Garonne	84 Vaucluse	
88 Vosges	89 Yonne	90 Territoire de Belfort	
94 Val de Marne			

This requirement is likely to change over time, allowing you to use your wireless LAN card in more areas within France. Please check with ART for the latest information ([www.arcep.fr](http://www.arcep.fr))



---

Your WLAN Card transmits less than 100mW, but more than 10mW.

---

## Canadian Department of Communications Statement

This digital apparatus does not exceed the Class B limits for radio noise emissions from digital apparatus set out in the Radio Interference Regulations of the Canadian Department of Communications.

This class B digital apparatus complies with Canadian ICES-003.

Cet appareil numérique de la classe [B] est conforme à la norme NMB-003 du Canada.

## IC Radiation Exposure Statement for Canada

This equipment complies with IC radiation exposure limits set forth for an uncontrolled environment. To maintain compliance with IC RF exposure compliance requirements, please avoid direct contact to the transmitting antenna during transmitting. End users must follow the specific operating instructions for satisfying RF exposure compliance.

Operation is subject to the following two conditions:

- This device may not cause interference and
- This device must accept any interference, including interference that may cause undesired operation of the device.

To prevent radio interference to the licensed service (i.e. co-channel Mobile Satellite systems) this device is intended to be operated indoors and away from windows to provide maximum shielding. Equipment (or its transmit antenna) that is installed outdoors is subject to licensing.



---

The user is cautioned that this device should be used only as specified within this manual to meet RF exposure requirements. Use of this device in a manner inconsistent with this manual could lead to excessive RF exposure conditions.

---

This device and its antenna(s) must not be co-located or operating in conjunction with any other antenna or transmitter.

Country Code selection feature to be disabled for products marketed to the US/CANADA.

# Safety information

## Electrical safety

- To prevent electrical shock hazard, disconnect the power cable from the electrical outlet before relocating the system.
- When adding or removing devices to or from the system, ensure that the power cables for the devices are unplugged before the signal cables are connected. If possible, disconnect all power cables from the existing system before you add a device.
- Before connecting or removing signal cables from the motherboard, ensure that all power cables are unplugged.
- Seek professional assistance before using an adapter or extension cord. These devices could interrupt the grounding circuit.
- Ensure that your power supply is set to the correct voltage in your area. If you are not sure about the voltage of the electrical outlet you are using, contact your local power company.
- If the power supply is broken, do not try to fix it by yourself. Contact a qualified service technician or your retailer.
- The optical S/PDIF is an optional component (may or may not be included in your motherboard) and is defined as a CLASS 1 LASER PRODUCT.



---

INVISIBLE LASER RADIATION, AVOID EXPOSURE TO BEAM.

---

- Never dispose of the battery in fire. It could explode and release harmful substances into the environment.
- Never dispose of the battery with your regular household waste. Take it to a hazardous material collection point.
- Never replace the battery with an incorrect battery type.



- 
- RISK OF EXPLOSION IF BATTERY IS REPLACED BY AN INCORRECT TYPE.
  - DISPOSE OF USED BATTERIES ACCORDING TO THE ABOVE BATTERY-RELATED INSTRUCTIONS.
-

## Operation safety

- Before installing the motherboard and adding devices on it, carefully read all the manuals that came with the package.
- Before using the product, ensure all cables are correctly connected and the power cables are not damaged. If you detect any damage, contact your dealer immediately.
- To avoid short circuits, keep paper clips, screws, and staples away from connectors, slots, sockets and circuitry.
- Avoid dust, humidity, and temperature extremes. Do not place the product in any area where it may become wet.



---

This motherboard should only be used in environments with ambient temperatures between 5°C (41°F) and 40°C (104°F).

---

- Place the product on a stable surface.
- If you encounter technical problems with the product, contact a qualified service technician or your retailer.

## REACH

Complying with the REACH (Registration, Evaluation, Authorisation, and Restriction of Chemicals) regulatory framework, we published the chemical substances in our products at ASUS REACH website at <http://csr.asus.com/english/REACH.htm>.



---

**DO NOT** throw the motherboard in municipal waste. This product has been designed to enable proper reuse of parts and recycling. This symbol of the crossed out wheeled bin indicates that the product (electrical and electronic equipment) should not be placed in municipal waste. Check local regulations for disposal of electronic products.

---



---

**DO NOT** throw the mercury-containing button cell battery in municipal waste. This symbol of the crossed out wheeled bin indicates that the battery should not be placed in municipal waste.

---

# About this guide

This user guide contains the information you need when installing and configuring the motherboard.

## How this guide is organized

This guide contains the following parts:

- **Chapter 1: Product introduction**  
This chapter describes the features of the motherboard and the new technology it supports.
- **Chapter 2: Hardware information**  
This chapter lists the hardware setup procedures that you have to perform when installing system components. It includes description of the switches, jumpers, and connectors on the motherboard.
- **Chapter 3: BIOS setup**  
This chapter tells how to change system settings through the BIOS Setup menus. Detailed descriptions of the BIOS parameters are also provided.
- **Chapter 4: Software support**  
This chapter describes the contents of the support DVD that comes with the motherboard package and the software.
- **Chapter 5: Multiple GPU technology support**  
This chapter describes how to install and configure multiple AMD CrossFireX™ and NVIDIA® SLI™ graphics cards.

## Where to find more information

Refer to the following sources for additional information and for product and software updates.

1. **ASUS websites**  
The ASUS website provides updated information on ASUS hardware and software products. Refer to the ASUS contact information.
2. **Optional documentation**  
Your product package may include optional documentation, such as warranty flyers, that may have been added by your dealer. These documents are not part of the standard package.



## Conventions used in this guide

To ensure that you perform certain tasks properly, take note of the following symbols used throughout this manual.



**DANGER/WARNING:** Information to prevent injury to yourself when trying to complete a task.



**CAUTION:** Information to prevent damage to the components when trying to complete a task.



**IMPORTANT:** Instructions that you **MUST** follow to complete a task.



**NOTE:** Tips and additional information to help you complete a task.

## Typography

### **Bold text**

Indicates a menu or an item to select.

### *Italics*

Used to emphasize a word or a phrase.

### <Key>

Keys enclosed in the less-than and greater-than sign means that you must press the enclosed key.

Example: <Enter> means that you must press the Enter or Return key.

### <Key1+Key2+Key3>

If you must press two or more keys simultaneously, the key names are linked with a plus sign (+).

Example: <Ctrl+Alt+Del>

### **Command**

Means that you must type the command exactly as shown, then supply the required item or value enclosed in brackets.

Example: At the DOS prompt, type the command line:

```
afudos /iR4F.ROM
```

# RAMPAGE IV FORMULA specifications summary

<b>CPU</b>	<p>2nd Generation Intel® Core™ i7 processor family for the LGA 2011 Socket</p> <p>Supports Intel® Turbo Boost Technology 2.0</p> <p>* Refer to <a href="http://www.asus.com">www.asus.com</a> for Intel CPU support list</p>
<b>Chipset</b>	Intel® X79 Express Chipset
<b>Memory</b>	<p>4 x DIMM, max. 32GB, DDR3 2400(O.C.)/ 2200(O.C.)/2133(O.C.)/2000(O.C.)/1800(O.C.)/1600/1333/1066 MHz, non-ECC, unbuffered memory modules</p> <p>Quad channel memory architecture</p> <p>Supports Intel® Extreme Memory Profile (XMP)</p> <p>* Hyper DIMM support is subject to the physical characteristics of individual CPUs. Some hyper DIMMs only support one DIMM per channel. Please refer to <a href="http://www.asus.com">www.asus.com</a> or this user manual for the Memory QVL (Qualified Vendors List) for details.</p>
<b>Expansion Slots</b>	<p>4 x PCIe3.0 x16 (red) slots, support x16; x16/x16; x16/x8/x16 and x16/x8/x8/x8 configurations</p> <p>2 x PCIe2.0 x1 slot</p> <p>* This motherboard is ready to support PCIe 3.0 SPEC. Functions will be available when using PCIe 3.0-compliant devices. Please refer to <a href="http://www.asus.com">www.asus.com</a> for updated details.</p>
<b>Multi-GPU Technology</b>	<p>Supports NVIDIA® 4-Way SLI™ / AMD 4-Way CrossFireX™ Technology</p> <p>* The 4-Way SLI™ bridge is sold separately.</p>
<b>Storage</b>	<p><b>Intel® X79 Express Chipset built-in:</b></p> <ul style="list-style-type: none"> <li>- 2 x SATA 6Gb/s ports (red)</li> <li>- 4 x SATA 3Gb/s ports (black)</li> <li>- Support Raid 0, 1, 5, 10</li> </ul> <p><b>ASMedia® ASM1061 controller:</b></p> <ul style="list-style-type: none"> <li>- 2 x SATA 6Gb/s port(s) (red)</li> <li>- 2 x eSATA 6Gb/s port(s)</li> </ul>
<b>LAN</b>	Intel® Gigabit LAN Controller
<b>Audio</b>	<p><b>SupremeFX III, built-in 8-Channel High Definition Audio CODEC</b></p> <ul style="list-style-type: none"> <li>- Output Signal-to-Noise Ratio (A-Weighted): 110 dB</li> <li>- Output THD+N at 1kHz: 95 dB</li> <li>- Supports: Jack-detection, Multi-streaming, Front Panel Jack-retasking</li> </ul> <p><b>Audio Feature:</b></p> <p>SupremeFX Shielding™ Technology</p> <p>1500 uF Audio Power Capacitor</p> <p>Golden-plated jacks</p> <ul style="list-style-type: none"> <li>- X-Fi® Xtreme Fidelity™</li> <li>- EAX® Advanced™ HD 5.0</li> <li>- THX® TruStudio PRO™</li> <li>- Creative® ALchemy</li> <li>- Blu-ray audio layer Content Protection</li> <li>- Optical S/PDIF out port(s) at back panel</li> </ul>

*(continued on the next page)*

# RAMPAGE IV FORMULA specifications summary

<b>USB</b>	<b>ASMedia® USB 3.0 controller:</b> <ul style="list-style-type: none"><li>- 6 x USB 3.0 port(s) (4 at back panel, 2 at mid-board )</li></ul> <b>Intel® X79 Chipset:</b> <ul style="list-style-type: none"><li>- 12 x USB 2.0 port(s) (6 ports at back panel, 1 for ROG Connect; 6 ports at mid-board)</li></ul>
<b>ROG Exclusive Features</b>	<b>ROG Extreme OC kit</b> <ul style="list-style-type: none"><li>- Slow Mode</li><li>- LN2 Mode</li><li>- PCIe x16 Lane switch</li><li>- Q_Reset</li><li>- EZ Plug</li></ul> <b>ROG Connect:</b> <ul style="list-style-type: none"><li>- RC Diagram</li><li>- RC Remote</li><li>- RC Poster</li><li>- GPU Tweakit</li></ul> <b>ROG Extreme Engine Digi+ II</b> <ul style="list-style-type: none"><li>- 8 phase CPU power</li><li>- 3 phase VCCSA power</li><li>- 2+2 phase DRAM power</li></ul> <b>UEFI BIOS features :</b> <ul style="list-style-type: none"><li>- ROG BIOS Print</li><li>- GPU.DIMM Post</li></ul> <b>CPU Level Up</b> <b>ROG GameFirst</b> <b>Probelt</b> <b>iROG</b> <b>Extreme Tweaker</b> <b>USB BIOS Flashback</b> <b>Loadline Calibration</b> <b>Intelligent overclocking tools</b> <ul style="list-style-type: none"><li>- ASUS AI Booster Utility</li><li>- O.C. Profile</li></ul> <b>Overclocking Protection</b> <ul style="list-style-type: none"><li>- COP EX (Component Overheat Protection - EX)</li><li>- Voltminder LED II</li><li>- ASUS C.P.R.(CPU Parameter Recall)</li></ul>

*(continued on the next page)*

# RAMPAGE IV FORMULA specifications summary

<p><b>Special Features</b></p>	<p><b>ASUS EPU Engine</b></p> <p><b>ASUS Exclusive Features</b></p> <ul style="list-style-type: none"> <li>- MemOK!</li> <li>- Onboard Switches: Power/Reset/Clr CMOS (at rear)</li> </ul> <p><b>ASUS Quiet Thermal Solution</b></p> <ul style="list-style-type: none"> <li>- ASUS Fan Xpert</li> </ul> <p><b>ASUS EZ DIY</b></p> <ul style="list-style-type: none"> <li>- ASUS O.C. Profile</li> <li>- ASUS CrashFree BIOS 3</li> <li>- ASUS EZ Flash 2</li> <li>- ASUS MyLogo 2</li> </ul> <p><b>ASUS Q-Design</b></p> <ul style="list-style-type: none"> <li>- ASUS Q-Connector</li> <li>- ASUS Q-LED (CPU, DRAM, VGA, Boot Device LED)</li> <li>- ASUS Q-Slot</li> <li>- ASUS Q-DIMM</li> </ul>
<p><b>Back I/O Ports</b></p>	<p>1 x PS/2 keyboard/mouse Combo port(s)            1 x Clear CMOS button(s)            1 x Optical S/PDIF out            1 x ROG Connect On/Off switch            6 x USB 2.0 port(s) (1 can be switched to ROG Connect)            4 x USB 3.0 port(s) (blue)            2 x eSATA 6Gb/s            1 x LAN (RJ45) port(s)            6 x Audio jack(s)</p>
<p><b>Internal I/O Connectors</b></p>	<p>1 x USB 3.0 connector(s) support(s) additional 2 USB 3.0 port(s)            3 x USB 2.0 connector(s) support(s) additional 6 USB 2.0 port(s)            4 x SATA 6Gb/s connector(s)            4 x SATA 3Gb/s connector(s)            2 x CPU Fan connector(s)            3 x Chassis Fan connector(s)            3 x Optional Fan connector(s)            1 x 24-pin EATX Power connector(s)            1 x 8-pin EATX 12V Power connector(s)            8 x Probelts Measurement Points            3 x Thermal sensor connector(s)            1 x EZ Plug connector(s) (4-pin Molex power connector)            1 x Power-on button(s)            1 x Reset button(s)            1 x Go Button(s)            1 x LN2 mode jumper            1 x Slow Mode switch            1 x S/PDIF out header(s)            1 x Front panel audio connector(s) (AAFP)            1 x System panel connector</p>

*(continued on the next page)*

# RAMPAGE IV FORMULA specifications summary

<b>BIOS</b>	2 x 64Mb UEFI BIOSs, PnP, DMI2.0, WfM2.0, SM BIOS 2.5, ACPI2.0a Multi-Language BIOS
<b>Manageability</b>	WfM2.0, DMI2.0, WOL by PME, WOR by PME, PXE
<b>Software</b>	Drivers Sound Blaster® X-Fi MB2 Utility Kaspersky® Anti-Virus DAEMON Tools Pro Standard ROG CPU-Z Mem Tweakit ASUS WebStorage ASUS Utilities
<b>Form Factor</b>	ATX Form Factor 12 inch x 9.6 inch (30.5cm x 24.4cm)

\*Specifications are subject to change without notice.



# Chapter 1

## 1.1 Welcome!

Thank you for buying an ROG RAMPAGE IV FORMULA motherboard!

The motherboard delivers a host of new features and latest technologies, making it another standout in the long line of ASUS quality motherboards!

Before you start installing the motherboard, and hardware devices on it, check the items in your package with the list below.

## 1.2 Package contents

Check your motherboard package for the following items.

Motherboard	ROG RAMPAGE IV FORMULA
Accessories	1 x ROG Connect cable 1 x 3-Way SLI bridge 1 x SLI bridge 1 x CrossFire cable 1 x 2-in-1 ASUS Q-Connector Kit 2 x 2-in-1 SATA 3Gb/s signal cables 2 x 2-in-1 SATA 6Gb/s signal cables 1 x I/O Shield 1 x ROG theme label 1 x 12-in-1 ROG Cable label 1 x X-Socket pad module
Application DVD	ROG motherboard support DVD
Documentation	User guide ROG exclusive feature guide



If any of the above items is damaged or missing, contact your retailer.

## 1.3 Special features

### 1.3.1 Product highlights

#### Republic of Gamers

The Republic of Gamers consists only the best of the best. We offer the best hardware engineering, the fastest performance, the most innovating ideas, and we welcome the best gamers to join in. In the Republic of Gamers, mercy rules are only for the weak, and bragging rights means everything. We believe in making statements and we excel in competitions. If your character matches our trait, then join the elite club, make your presence felt, in the Republic of Gamers.

#### LGA2011 Intel® Sandy Bridge-E Processor

This motherboard supports the latest Intel® Sandy Bridge-E processors in the LGA2011 package, with memory and PCI Express controllers integrated to support 4-channel (4 DIMM) DDR3 memory and x16 PCI Express 3.0 lanes. This provides great graphics performance. Intel® Sandy Bridge-E processors are among the most powerful and energy efficient CPUs in the world.

#### Intel® X79 Express Chipset

The Intel® X79 Express Chipset is the latest single-chipset design that supports the new socket 2011 Intel® Core™ i7 Extreme Edition processors. It improves performance by utilizing serial point-to-point links, allowing for increased bandwidth and stability. Additionally, the X79 comes with 2 SATA 6Gb/s and 4 SATA 3Gb/s ports for faster data retrieval, doubling the bandwidth of current bus systems.

#### PCIe 3.0 Ready

The latest PCI Express bus standard delivers improved encoding for twice the performance of current PCIe 2.0. Total bandwidth for a x16 link reaches a maximum of 32GB/s, double the 16GB/s of PCIe 2.0 (in x16 mode). PCIe 3.0 provides users unprecedented data speeds, combined with the convenience and seamless transition offered by complete backward compatibility with PCIe 1.0 and PCIe 2.0 devices. It is a must-have feature PC users aiming to improve and optimize graphics performance, as well as have the latest, most future-proof technology.

\* This motherboard is ready to support PCIe 3.0 SPEC. Functions will be available when using PCIe 3.0-compliant devices. Please refer to [www.asus.com](http://www.asus.com) for updated details.

#### SLI/CrossFire On-Demand

##### Why choose when you can have both?

SLI or CrossFireX? Fret no longer because with the ROG RAMPAGE IV FORMULA, you'll be able to run both multi-GPU setups. The board features SLI/CrossFireX on Demand technology, supporting SLI or CrossFireX configuration. Whichever path you take, you can be assured of jaw-dropping graphics at a level previously unseen.

#### Quad-Channel DDR3 2400(O.C.) support

The motherboard supports DDR3 memory that features data transfer rates of 2400(O.C.)/2200(O.C.)/2133(O.C.)/2000(O.C.)/1800(O.C.)/1600/1333/1066 MHz to meet the higher bandwidth requirements of the latest 3D graphics, multimedia, and Internet applications. The quad-channel DDR3 architecture enlarges the bandwidth of your system memory to boost system performance.



## 1.3.2 ROG Exclusive Features

### Extreme Engine Digi+ II

#### **Optimum power efficiency with premium components and intelligent digital design**

The Extreme Engine Digi+ II has been upgraded and equipped with the finest Japan-made 10K Black Metallic capacitors, while the digital VRM design allows you to achieve ultimate performance with adjustable CPU and memory power management frequencies. Precise adjustments create greater efficiency, stability, double lifespan and performance for total system control.

### ROG Connect

#### **Plug and Overclock - Tweak it the hardcore way!**

Monitor the status of your desktop PC and tweak its parameters in real-time via a notebook—just like a race car engineer—with ROG Connect. ROG Connect links your main system to a notebook through a USB cable, allowing you to view real-time POST code and hardware status readouts on your notebook, as well as make on-the-fly parameter adjustments at a purely hardware level.

### ROG GameFirst

#### **The speed you need to pwn**

Low Internet latency allows you to frag more, and get fragged less. That's why ROG has introduced GameFirst, a feature that manages the flow of traffic according to your needs so that you can still listen to online music, download and upload files, and engage in Internet chats without sacrificing the low ping times you need to pwn your opponents.

### X-Socket

#### **Pull the ol' switcharoo**

Don't junk that expensive LGA1366 heatsink! With X-Socket, switch out the LGA2011 pad for a 1366 one and get more life out of your previous CPU cooler.

### ROG BIOS Print

#### **One click, easily share your BIOS settings**

ROG offers a whole new EFI BIOS feature to handle the demands of an overclocking experience. RAMPAGE IV FORMULA features ROG BIOS Print which allows users to easily share their BIOS settings to others with the press of a button. The days of using a camera to take BIOS screenshot are over.

### GPU.DIMM Post

#### **Easily check the status of your graphics cards and memory in the BIOS!**

Notice potential problems even before you enter the OS! Overclockers can save valuable minutes in detecting component failure under extreme conditions. With GPU.DIMM Post, quickly and easily check your graphics cards and memory DIMMs status in the BIOS, potentially keeping that record-breaking overclock!

## Probelt

### **Get all hands-on with hardware-based overclocking.**

Probelt takes the guesswork out of locating the motherboard's measurement points, identifying them clearly in the form of eight sets of detection points so you'll know exactly where to get quick yet accurate readings using a multimeter.

## iROG

### **Intelligent multiple control at hand**

The iROG is a special IC which enables several ROG highlighted functions that gives users full disposal of the motherboard at any stage! This design allows advanced user control and management to be processed purely at a hardware level. iROG greatly increases fun during overclocking for PC enthusiasts and it offers system maintenance and management with more control and efficiency.

## BIOS FlashBack

### **Two BIOS ROM. Two BIOS settings. Twice the overclocking flexibility.**

Overclocker's prayer to have BIOS flexibility is answered! With the new BIOS Flashback, PC enthusiasts can overclock with even more confidence. BIOS Flashback gives overclockers the ability to save two versions of the BIOS simultaneously. Very much like the "SaveGame" function, one BIOS can be used for the overclocking adventure, while the other BIOS is to be stored with any previous version. BIOS Flashback brings the ultimate convenience to overclockers!

## USB BIOS FlashBack

### **Refresh the BIOS can never be that easy**

USB BIOS Flashback must be the most convenient way to flash BIOS ever! It allows overclockers to try their BIOS with the simplest way one can imagine. No need to enter the BIOS or the operating system, just plug the thumb drive into the ROG Connect port & push the ROG Connect button for 3 seconds, BIOS would be automatically flashed under standby power. It's no doubt that USB BIOS Flashback gives overclockers the ultimate convenience!

## CPU Level Up

### **A simple click for instant upgrade!**

Ever wish that you could have a more expensive CPU? Upgrade your CPU at no additional cost with ROG's CPU Level Up! Simply pick the processor you wanted to OC to, and the motherboard will do the rest! See the new CPU speed and enjoy that performance instantly. Overclocking is never as easy as this.

## Extreme Tweaker

### **One stop performance tuning shop**

Extreme Tweakers is the one stop shop to fine-tune your system to optimal performance. No matter if you're looking for frequency adjustment, over-voltage options, or memory timing settings, they're all here!

## Voltiminder LED II

### Friendly reminder on Voltage Settings

In the pursuit of extreme performance, overvoltage adjustment is critical but risky. Acting as the “red zone” of a tachometer, the Voltiminder LED displays the voltage status for CPU, NB, SB, and Memory in a intuitive color-coded fashion. The Voltiminder LED allows quick voltage monitoring for overclockers.

## COP EX

### Maximum OC with confidence with burn proof protection to chipsets and GPU!

The COP EX allows overclockers to increase chipset voltages without the worries of overheating. It can also be used to monitor and save an overheating GPU. The COP EX allows more freedom and less constraint for maximum performance achievement.

## Loadline Calibration

### Optimal power boost for extreme CPU overclocking!

Maintaining ample voltage support for the CPU is critical during overclocking. The Loadline Calibration ensures stable and optimal CPU voltage under heavy loading. It helps overclockers enjoy the motherboard's ultimate OC capabilities and benchmark scores.

### 1.3.3 Sound with Clarity

## SupremeFX III

### Supreme Sound

The SupremeFX III™ onboard audio solution is an 8-channel HD audio equipped with a carefully selected 1500uF capacitor which provides clean, ripple-free audio power and – perfect for enveloping gaming environments. With a metallic EMI cover and special layout design on the PCB, advanced SupremeFX Shielding™ technology isolates analog audio signals from digital sources for exceptional clarity and high fidelity, while a golden-plated jack ensures rich notes reach your ears with minimal distortion. In real world testing, a signal-to-noise ratio (SNR) of 110dB was achieved, yielding almost lossless audio.

A bounty of industry standards are supported, including EAX® 5.0 Advanced HD, Creative® ALchemy and THX® TruStudio™ PRO, so the same great audio experiences found in live performances, films and recording studios are reproduced faithfully right on the PC. When bundled with the Sound Blaster® X-Fi MB2 suite, the SupremeFX III™ is the perfect choice to provide an exceptional gaming experience with realistic sound effects.

### 1.3.4 Future Transfer Technology

## True USB 3.0 Support

### 10X faster data rates!

Experience ultra-fast data transfers at 4.8Gbps with USB 3.0—the latest connectivity standard. Built to connect easily with next generation components and peripherals, USB 3.0 transfers data 10X faster and is also backward compatible with USB 2.0 components.

## True SATA 6Gb/s Support

### Experience the future of storage!

Supporting next-generation Serial ATA (SATA) storage interface, this motherboard delivers up to 6.0Gb/s data transfer rates. Additionally, get enhanced scalability, faster data retrieval, double the bandwidth of current bus systems.

## 1.3.5 Software Bundled

### Kaspersky® Anti-Virus

#### The best protection from viruses and spyware

Kaspersky® Anti-Virus Personal offers premium antivirus protection for individual users and home offices. It is based on advanced antivirus technologies. The product incorporates the Kaspersky® Anti-Virus engine, which is renowned for malicious program detection rates that is among the industry's highest.

### DAEMON Tools Pro Standard

#### The real tool for optical and virtual discs

DAEMON Tools Pro offers essential functionality to backup CD, DVD and Blu-ray discs. It converts optical media into virtual discs and emulates devices to work with the virtual copies. DAEMON Tools Pro organizes data, music, video and photo collections on a PC, notebook or netbook.

### ROG CPU-Z

#### Whole new design of CPU-Z

ROG CPU-Z is a customized ROG version authorized by CPUID. It has the same functionality and credibility as the original version, with a unique design. Use the whole new look of ROG CPU-Z to truly report your CPU related information and your uniqueness.

### Mem TweakIt

#### Dynamic timing adjustments, DRAM efficiency gauge

When changing DRAM settings in BIOS, it always takes time for the system to reboot. Worry no more! With Mem TweakIt, you can do DRAM tuning in real-time, view your DRAM efficiency score, and upload and share your ranking online.

## 2.1 Before you proceed

Take note of the following precautions before you install motherboard components or change any motherboard settings.



- 
- Unplug the power cord from the wall socket before touching any component.
  - Before handling components, use a grounded wrist strap or touch a safely grounded object or a metal object, such as the power supply case, to avoid damaging them due to static electricity.
  - Hold components by the edges to avoid touching the ICs on them.
  - Whenever you uninstall any component, place it on a grounded antistatic pad or in the bag that came with the component.
  - Before you install or remove any component, ensure that the ATX power supply is switched off or the power cord is detached from the power supply. Failure to do so may cause severe damage to the motherboard, peripherals, or components.
-

## 2.2 Motherboard overview

### 2.2.1 Motherboard layout

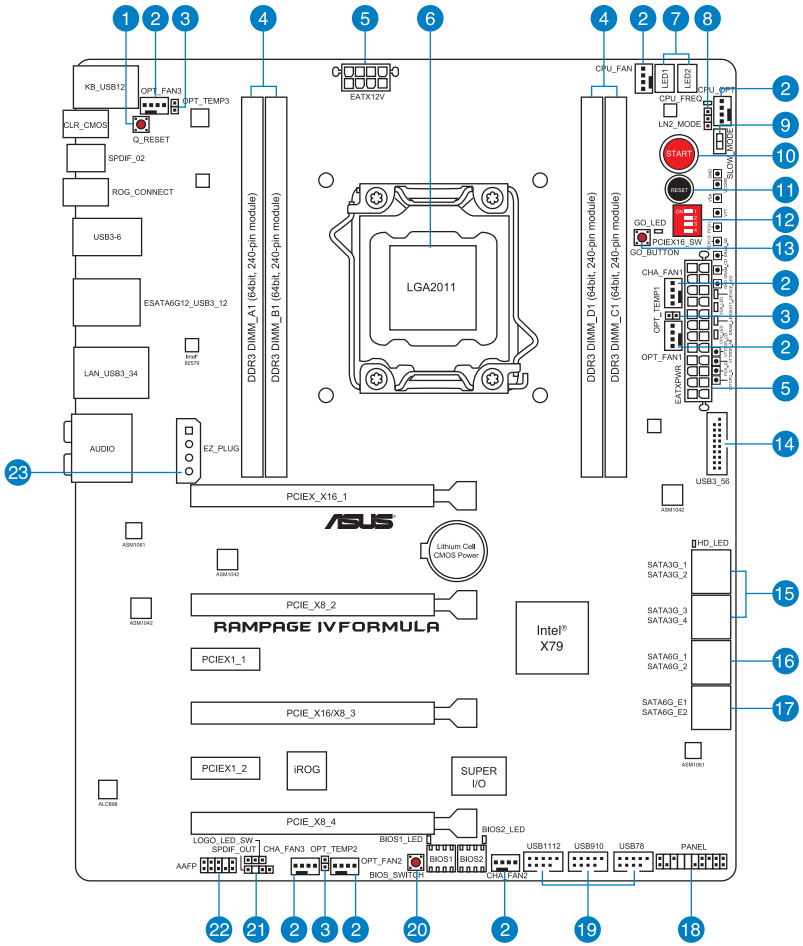

Refer to 2.2.8 Internal connectors and 2.3.10 Rear panel connection for more information about rear panel connectors and internal connectors.

## Layout contents

Connectors/Jumpers/Slots		Page
1.	Q Reset button	2-16
2.	CPU, chassis and power fan connectors (4-pin CPU_FAN; 4-pin CPU_OPT; 4-pin CHA_FAN1/2/3; 4-pin OPT_FAN1/2/3)	2-33
3.	Thermal sensor cable connectors (2-pin OPT_TEMP1-3)	2-30
4.	DDR3 DIMM slots channel A, B, C and D	2-5
5.	ATX power connectors (24-pin EATXPWR; 8-pin EATX12V)	2-34
6.	LGA2011 CPU socket	2-4
7.	Debug LEDs	2-21
8.	LN2 Mode jumper	2-26
9.	Slow Mode Switch	2-17
10.	Power-on Switch	2-14
11.	Reset Switch	2-14
12.	PCIe x16 Lane Switch	2-16
13.	Go Button	2-15
14.	USB 3.0 connector (20-1 pin USB3_56)	2-30
15.	Intel X79 Serial ATA 3Gb/s connectors (7-pin SATA3G_1-4 [black])	2-28
16.	Intel X79 Serial ATA 6Gb/s connectors (7-pin SATA6G_1/2 [red])	2-27
17.	ASMedia Serial ATA 6Gb/s connectors (7-pin SATA6G_E1/E2 [red])	2-29
18.	System panel connector (20-8 pin PANEL)	2-37
19.	USB 2.0 connectors (10-1 pin USB78; USB910; USB1112)	2-31
20.	BIOS button	2-15
21.	Digital audio connector (4-1 pin SPDIF_OUT)	2-32
22.	Front panel audio connector (10-1 pin AAFP)	2-34
23.	EZ Plug connector (4-pin EZ-PLUG)	2-36

## 2.2.2 Central Processing Unit (CPU)

The motherboard comes with a surface mount LGA2011 socket designed for the Intel® 2nd Generation Core™ i7 Processor Extreme Edition.

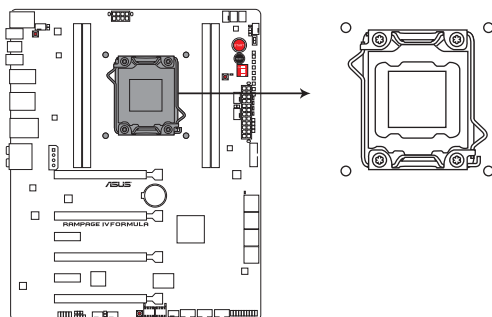

**RAMPAGE IV FORMULA CPU LGA2011**



---

Ensure that all power cables are unplugged before installing the CPU.

---



- Upon purchase of the motherboard, ensure that the PnP cap is on the socket and the socket contacts are not bent. Contact your retailer immediately if the PnP cap is missing, or if you see any damage to the PnP cap/socket contacts/motherboard components. ASUS will shoulder the cost of repair only if the damage is shipment/transit-related.
  - Keep the cap after installing the motherboard. ASUS will process Return Merchandise Authorization (RMA) requests only if the motherboard comes with the cap on the LGA2011 socket.
  - The product warranty does not cover damage to the socket contacts resulting from incorrect CPU installation/removal, or misplacement/loss/incorrect removal of the PnP cap.
-



## 2.2.3 System memory

The motherboard comes with four Double Data Rate 3 (DDR3) Dual Inline Memory Modules (DIMM) slots.



A DDR3 module is notched differently from a DDR or DDR2 module. DO NOT install a DDR or DDR2 memory module to the DDR3 slot.

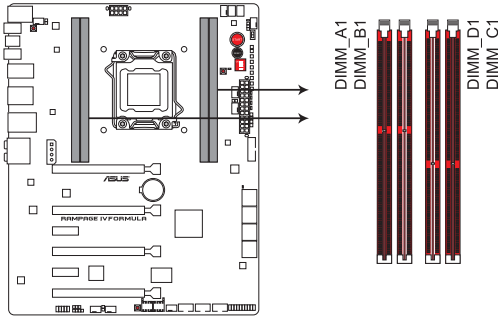

RAMPAGE IV FORMULA 240-pin DDR3 DIMM socket

### Recommended memory configurations

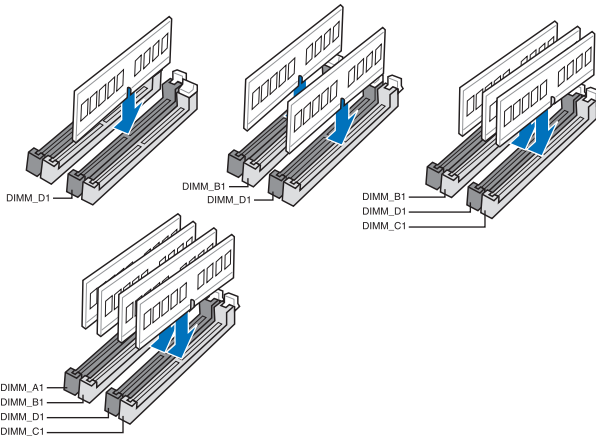

## Memory configurations

You may install 1GB, 2GB, 4GB and 8GB unbuffered and non-ECC DDR3 DIMMs into the DIMM sockets.



- You may install varying memory sizes in Channel A, Channel B, Channel C and Channel D. The system maps the total size of the lower-sized channel for the dual-channel, triple-channel and quad-channel configuration. Any excess memory from the higher-sized channel is then mapped for single-channel operation.
- Due to CPU behavior, DDR3 2200/2000/1800 MHz memory module will run at DDR3 2133/1866/1600 MHz frequency as default.
- According to Intel® spec, the max. 32GB memory capacity can be supported with DIMMs of 8GB (or above). ASUS will update QVL once the DIMMs are available on the market.
- According to Intel CPU spec, DIMM voltage below 1.65V is recommended to protect the CPU.
- Always install DIMMs with the same CAS latency. For optimum compatibility, we recommend that you obtain memory modules from the same vendor.
- Due to the memory address limitation on 32-bit Windows OS, when you install 4GB or more memory on the motherboard, the actual usable memory for the OS can be about 3GB or less. For effective use of memory, we recommend that you do any of the following:
  - Use a maximum of 3GB system memory if you are using a 32-bit Windows OS.
  - Install a 64-bit Windows OS when you want to install 4GB or more on the motherboard.For more details, refer to the Microsoft® support site at <http://support.microsoft.com/kb/929605/en-us>.
- This motherboard does not support DIMMs made up of 512Mb (64MB) chips or less (Memory chip capacity counts in Megabit, 8 Megabit/Mb = 1 Megabyte/MB).



- The default memory operation frequency is dependent on its Serial Presence Detect (SPD), which is the standard way of accessing information from a memory module. Under the default state, some memory modules for overclocking may operate at a lower frequency than the vendor-marked value. To operate at the vendor-marked or at a higher frequency, refer to section **3.3 Extreme Tweaker menu** for manual memory frequency adjustment.
- For system stability, use a more efficient memory cooling system to support a full memory load (4 DIMMs) or overclocking condition.

# RAMPAGE IV FORMULA Motherboard Qualified Vendors Lists (QVL) DDR3 1333 MHz capability

Vendors	Part No.	Size	SS/ DS	Chip Brand	Chip NO.	Timing	Voltage	DIMM socket support (Optional)	
								1 DIMM	4 DIMM
A-DATA	AD631B0823EV	2GB	SS	A-DATA	3CCA-1509A	-	-	*	*
A-DATA	AXDU11333GC2G9(XMP)	2GB	SS	-	-	9-9-9-24	1.25-1.35	*	*
A-DATA	AD631C1624EV	4GB	DS	A-DATA	3CCA-1509A	-	-	*	*
A-DATA	SU3U11333W8G9(XMP)	8GB	DS	ELPIDA	J4208BASE-DJ-F	-	-	*	*
Apacer	78.01GC6.9L0	1GB	SS	Apacer	AM5D5808DEJSBG	9	-	*	*
Apacer	78.A1GC6.9L1	2GB	DS	Apacer	AM5D5808FEQSBG	9	-	*	*
Apacer	78.B1GDE.9L10C	4GB	DS	Apacer	AM5D5908CEHSBG	9	-	*	*
CORSAIR	TW3X4G1333C9A	4GB ( 2x 2GB)	DS	-	-	9-9-9-24	1.5	*	*
CORSAIR	CMX8GX3M2A1333C9(XMP)	8GB ( 2x 4GB)	DS	-	-	9-9-9-24	1.5	*	*
CORSAIR	CMX8GX3M4A1333C9	8GB(4 x 2GB)	DS	-	-	9-9-9-24	1.5	*	*
Crucial	BL25664BN1337.16FF(XMP)	2GB	DS	-	-	7-7-7-24	1.65	*	*
ELPIDA	EBJ41UF8BCFO-DJ-F	4GB	DS	ELPIDA	J2108BCSE-DJ-F	-	-	*	*
G.SKILL	F3-10600CL9D-4GBNT	4GB ( 2x 2GB)	DS	G.SKILL	D3 128M8CE9 2GB	9-9-9-24	1.5	*	*
G.SKILL	F3-10666CL7D-4GBRH(XMP)	4GB(2 x 2GB)	DS	-	-	7-7-7-21	1.5	*	*
G.SKILL	F3-10666CL8D-4GBECO(XMP)	4GB(2 x 2GB)	DS	-	-	8-8-8-24	1.35	*	*
G.SKILL	F3-10666CL9D-8GBRL	8GB ( 2x 4GB)	DS	-	-	9-9-9-24	1.5	*	*
G.SKILL	F3-10666CL9D-8GBRL	8GB ( 2x 4GB)	DS	-	-	9-9-9-24	1.5	*	*
G.SKILL	F3-10666CL9D-8GBXL	8GB ( 2x 4GB)	DS	-	-	9-9-9-24	1.5	*	*
GEIL	GET316GB1333C9QC	16GB ( 4x 4GB)	DS	-	-	9-9-9-24	1.5	*	*
GEIL	GG34GB1333C9DC	4GB ( 2x 2GB)	DS	GEIL	GL1L128M88BA115FW	9-9-9-24	1.3	*	*
GEIL	GG34GB1333C9DC	4GB ( 2x 2GB)	DS	GEIL	GL1L128M88BA15B	9-9-9-24	1.3	*	*
GEIL	GVP34GB1333C9DC	4GB ( 2x 2GB)	DS	-	-	9-9-9-24	1.5	*	*
GEIL	GB34GB1333C7DC	4GB(2 x 2GB)	DS	GEIL	GL1L128M88BA15FW	7-7-7-24	1.5	*	*
GEIL	GG34GB1333C9DC	4GB(2 x 2GB)	DS	GEIL	GL1L128M88BA12N	9-9-9-24	1.3	*	*
GEIL	GVP38GB1333C9DC	8GB ( 2x 4GB)	DS	-	-	9-9-9-24	1.5	*	*
Hynix	HMT112U6TFR8A-H9	1GB	SS	Hynix	H5TC1G83TFR	-	-	*	*
Hynix	HMT125U6BFR8C-H9	2GB	SS	Hynix	H5TQ2G83BFR	-	-	*	*
Hynix	HMT125U6BFR8C-H9	2GB	DS	Hynix	H5TQ1G83BFRH9C	9	-	*	*
Hynix	HMT125U6TFR8A-H9	2GB	DS	Hynix	H5TC1G83TFR	-	-	*	*
KINGMAX	FLFE85F-C8KL9	2GB	SS	KINGMAX	KFC8FNLXF-DXX-15A	-	-	*	*
KINGMAX	FLFE85F-B8KL9	2GB	DS	KINGMAX	KFB8FNLXL-BNF-15A	-	-	*	*
KINGMAX	FLFF65F-C8KL9	4GB	DS	KINGMAX	KFC8FNLXF-DXX-15A	-	-	*	*
KINGMAX	FLFF65F-C8KM9	4GB	DS	Kingmax	KFC8FNMXF-BXX-15A	-	-	*	*
KINGSTON	KVR1333D3N9/1G	1GB	SS	Elpida	J1108BDSE-DJ-F	9	1.5	*	*
KINGSTON	KVR1333D3S8N9/2G	2GB	SS	Micron	IFD77 D9L GK	-	-	*	*
KINGSTON	KVR1333D3N9/2G	2GB	DS	Kingston	D1288JPNDDL9U	9	1.5	*	*
KINGSTON	KVR1333D3N9K2/4G	4GB ( 2x 2GB)	DS	KINGSTON	D1288JEMFPGD9U	-	1.5	*	*
KINGSTON	KVR1333D3E9S/4G	4GB	DS	Elpida	J2108ECSE-DJ-F	9	1.5	*	*
MICRON	MT4JTF12864AZ-1G4D1	1GB	SS	Micron	D9L GK	-	-	*	*
MICRON	MT8JTF25664AZ-1G4D1	2GB	SS	Micron	D9L GK	-	-	*	*
MICRON	MT8JTF25664AZ-1G4D1	2GB	SS	Micron	D9L GK	-	-	*	*
MICRON	MT8JTF25664AZ-1G4M1	2GB	SS	MICRON	D9PFJ	-	-	*	*
MICRON	MT16JTF51284AZ-1G4D1	4GB	DS	Micron	D9L GK	-	-	*	*
OCZ	OCZ3P1333LV3GK	3GB(3 x 1GB)	SS	-	-	7-7-7	1.65	*	*
OCZ	OCZ3G1333LV4GK	4GB ( 2x 2GB)	DS	-	-	9-9-9	1.65	*	*
OCZ	OCZ3P1333LV4GK	4GB(2 x 2GB)	DS	-	-	7-7-7	1.65	*	*
OCZ	OCZ3G1333LV8GK	8GB ( 2x 4GB)	DS	-	-	9-9-9	1.65	*	*
OCZ	OCZ3G1333LV8GK	8GB ( 2x 4GB)	DS	-	-	9-9-9	1.65	*	*
PSC	PC310600U-9-10-A0	1GB	SS	PSC	A3P1GF3FGF	-	-	*	*
PSC	PC310600U-9-10-B0	2GB	DS	PSC	A3P1GF3FGF	-	-	*	*
SAMSUNG	M378B2873EH1-CH9	1GB	SS	SAMSUNG	K4B1G0846E	-	-	*	*
SAMSUNG	M378B2873FHS-CH9	1GB	SS	SAMSUNG	K4B1G0846F	-	-	*	*
SAMSUNG	M378B573DHO-CH9	2GB	SS	SAMSUNG	K4B2G08460	-	-	*	*
SAMSUNG	M378B5673FH0-CH9	2GB	DS	SAMSUNG	K4B1G0846F	-	-	*	*
SAMSUNG	M378B5273BH1-CH9	4GB	DS	SAMSUNG	K4B2G0846B-HCH9	9	-	*	*
SAMSUNG	M378B5273CHO-CH9	4GB	DS	SAMSUNG	K4B2G0846C	K4B2G0846C	-	*	*
SAMSUNG	M378B5273DHO-CH9	4GB	DS	SAMSUNG	K4B2G08460	-	-	*	*
SAMSUNG	M378B1G73AH0-CH9	8GB	DS	SAMSUNG	K4B4G0846A-HCH9	-	-	*	*
Transcend	JM1333KLN-2G	2GB	SS	Transcend	TK483PCW3	-	-	*	*

## RAMPAGE IV FORMULA Motherboard Qualified Vendors Lists (QVL) DDR3 1333 MHz capability

Vendors	Part No.	Size	SS/ DS	Chip Brand	Chip NO.	Timing	Voltage	DIMM socket support (Optional)	
								1 DIMM	4 DIMM
Transcend	TS256MLK64V3N ( 585541 )	2GB	SS	Micron	ICD77 D9L GK	9	-	-	-
Transcend	TS256MLK64V3N (574206)	2GB	SS	Micron	D9L GK	9	-	-	-
Transcend	JM1333KLN-4G ( 583782 )	4GB	DS	Transcend	TK483PCW3	9	-	-	-
Transcend	JM1333KLN-4G	4GB	DS	Transcend	TK483PCW3	9	-	-	-
Transcend	TS512MLK64V3N ( 585538 )	4GB	DS	Micron	IED27 D9L GK	9	-	-	-
ACTICA	ACT1GHU64B8F1333S	1GB	SS	SAMSUNG	K4B1G0846F	-	-	-	-
ACTICA	ACT1GHU72C8G1333S	1GB	SS	SAMSUNG	K4B1G0846F(ECC)	-	-	-	-
ACTICA	ACT2GHU64B8G1333M	2GB	DS	Micron	D9KPT	-	-	-	-
ACTICA	ACT2GHU64B8G1333S	2GB	DS	SAMSUNG	K4B1G0846F	-	-	-	-
ACTICA	ACT2GHU72D8G1333M	2GB	DS	Micron	D9KPT(ECC)	-	-	-	-
ACTICA	ACT2GHU72D8G1333S	2GB	DS	SAMSUNG	K4B1G0846F(ECC)	-	-	-	-
ACTICA	ACT4GHU64B8H1333H	4GB	DS	Hynix	H5TQ2G83AFR	-	-	-	-
ACTICA	ACT4GHU72D8H1333H	4GB	DS	Hynix	H5TQ2G83AFR(ECC)	-	-	-	-
ATP	AQ56M72E8BJH9S	2GB	DS	SAMSUNG	K4B1G0846F(ECC)	-	-	-	-
ATP	AQ12M72E8BKH9S	4GB	DS	SAMSUNG	K4B2G0846C(ECC)	-	-	-	-
BUFFALO	D3U1333-1G	1GB	SS	Elpida	J1108BFBG-DJ-F	-	-	-	-
BUFFALO	D3U1333-2G	2GB	DS	Elpida	J1108BFBG-DJ-F	-	-	-	-
BUFFALO	D3U1333-4G	4GB	DS	NANYA	NT5CB256M8B8N-CG	-	-	-	-
EX Memory	EKM324L28BP9-I13	4GB(2 x 2GB)	DS	-	-	9	-	-	-
Elixir	M2F2G64C8B8B7N-CG	2GB	SS	Elixir	N2CB2G808N-CG	-	-	-	-
Elixir	M2F2G64C8B8D7N-CG	2GB	SS	Elixir	M2CB2G8BDN-CG	-	-	-	-
Elixir	M2F4G64C8B8B5N-CG	4GB	DS	Elixir	N2CB2G808N-CG	-	-	-	-
Elixir	M2F4G64C8B8D5N-CG	4GB	DS	Elixir	M2CB2G8BDN-CG	-	-	-	-
KINGTIGER	F10DA2T1680	2GB	DS	KINGTIGER	KTG1333PS1208NST-C9	-	-	-	-
KINGTIGER	KTG2G1333PG3	2GB	DS	-	-	-	-	-	-
Patriot	PSD32G13332	2GB	DS	Patriot	PM128M8D3BU-15	9	-	-	-
Patriot	PGS34G1333LLKA	4GB(2 x 2GB)	DS	-	-	7-7-20	1.7	-	-
Patriot	PG38G1333EL(XMP)	8GB	DS	-	-	-	1.5	-	-
RIDATA	C304627CB1AG22Fe	2GB	DS	RIDATA	C304627CB1AG22Fe	9	-	-	-
RIDATA	E304459CB1AG32Cf	4GB	DS	RIDATA	E304459CB1AG32Cf	9	-	-	-
Silicon Power	SP001GBLTU1333S01	1GB	SS	NANYA	NT5CB128M8AN-CG	-	-	-	-
Silicon Power	SP001GBLTU1333S01	1GB	SS	NANYA	NT5CB128M8AN-CG	-	-	-	-
Silicon Power	SP001GBLTU1333S02	1GB	SS	S-POWER	10YT3E5	9	-	-	-
Silicon Power	SP002GBLTU1333S01	2GB	DS	NANYA	NT5CB128M8AN-CG	-	-	-	-
Silicon Power	SP002GBLTU1333S02	2GB	DS	S-POWER	10YT3E0	9	-	-	-
Team	TXD31024M1333C7(XMP)	1GB	SS	Team	T3D1288LT-13	7-7-21	1.75	-	-
Team	TXD31048M1333C7-D(XMP)	1GB	SS	Team	T3D1288LT-13	7-7-21	1.75	-	-
Team	TXD32048M1333C7-D(XMP)	2GB	DS	Team	T3D1288LT-13	7-7-21	1.5-1.6	-	-

## RAMPAGE IV FORMULA Motherboard Qualified Vendors Lists (QVL) DDR3 1600 MHz capability

Vendors	Part No.	Size	SS/DS	Chip Brand	Chip NO.	Timing	Voltage	DIMM socket support (Optional)	
								1 DIMM	4 DIMM
A-DATA	AM2U16BC2P1	2GB	SS	A-DATA	3CCD-1509A	-	-	-	-
A-DATA	AX3U1600XC2G79(XMP)	2GB	SS	-	-	9-9-24	1.6-1.8	-	-
A-DATA	AM2U16BC4P2	4GB	DS	A-DATA	3CCD-1509A	-	-	-	-
A-DATA	AX3U1600GC4G9(XMP)	4GB	DS	-	-	-	1.55-1.75	-	-
A-DATA	AX3U1600PC4G8(XMP)	4GB	DS	-	-	8-8-8-24	1.55-1.75	-	-
CORSAIR	HX3X12G1600C8(XMP)	12GB ( 6x 2GB )	DS	-	-	9-9-24	1.6	-	-
CORSAIR	CMZ16GX3M4A1600C9(XMP)	16GB ( 4x 4GB )	DS	-	-	9-9-24	1.5	-	-
CORSAIR	CMG4GX3M2A1600C6	4GB ( 2x 2GB )	DS	-	-	6-6-6-18	1.65	-	-
CORSAIR	CMD4GX3M2B1600C8	4GB( 2x 2GB )	DS	-	-	8-8-8-24	1.65	-	-
CORSAIR	CMX4GX3M2A1600C8(XMP)	4GB( 2x 2GB )	DS	-	-	8-8-8-24	1.65	-	-
CORSAIR	CMP6GX3M3A1600C8(XMP)	6GB ( 3x 2GB )	DS	-	-	8-8-8-24	1.65	-	-
CORSAIR	CMP6GX3M3A1600C8(XMP)	6GB ( 3x 2GB )	DS	-	-	8-8-8-24	1.65	-	-
CORSAIR	CMX6GX3M3C1600C7(XMP)	6GB ( 3x 2GB )	DS	-	-	7-8-7-20	1.65	-	-
CORSAIR	CMZ8GX3M2A1600C8(XMP)	8GB ( 2x 4GB )	DS	-	-	8-8-8-24	1.5	-	-
CORSAIR	CMZ8GX3M2A1600C9(XMP)	8GB ( 2x 4GB )	DS	-	-	9-9-24	1.5	-	-

## RAMPAGE IV FORMULA Motherboard Qualified Vendors Lists (QVL) DDR3 1600 MHz capability

Vendors	Part No.	Size	SS/DS	Chip Brand	Chip NO.	Timing	Voltage	DIMM socket support (Optional)	
								1 DIMM	4 DIMM
Crucial	BL12864BN1608.8FF(XMP)	2GB( 2x 1GB )	SS	-	-	8-8-8-24	1.65	•	
Crucial	BL25664BN1608.16FF(XMP)	2GB	DS	-	-	8-8-8-24	1.65	•	
G.SKILL	F3-12800CL7Q-16GBXH(XMP)	16GB ( 4x 4GB )	DS	-	-	7-8-7-24	1.6	•	
G.SKILL	F3-12800CL9Q-16GBXL(XMP)	16GB ( 4x 4GB )	DS	-	-	9-9-9-24	1.5	•	
G.SKILL	F3-12800CL7D-4GBECO(XMP)	4GB(2 x 2GB)	DS	-	-	7-8-7-24	-	•	
G.SKILL	F3-12800CL8D-4GBRM(XMP)	4GB(2 x 2GB)	DS	-	-	8-8-8-24	1.6	•	
G.SKILL	F3-12800CL9D-4GBECO(XMP)	4GB(2 x 2GB)	DS	-	-	9-9-9-24	1.35	•	
G.SKILL	F3-12800CL7D-8GBRH(XMP)	8GB ( 2x 4GB )	DS	-	-	7-8-7-24	1.6	•	
G.SKILL	F3-12800CL9D-8GBRL(XMP)	8GB ( 2x 4GB )	DS	-	-	9-9-9-24	1.5	•	
G.SKILL	F3-12800CL9D-8GBSR2(XMP)	8GB ( 2x 4GB )	DS	-	-	9-9-9-24	1.25	•	
G.SKILL	F3-12800CL8D-8GBECO(XMP)	8GB ( 2x4GB )	DS	-	-	8-8-8-24	1.35	•	
GEIL	GET316GB1600C9QC(XMP)	16GB ( 4x 4GB )	DS	-	-	9-9-9-28	1.6	•	
GEIL	GUP34GB1600C7DC(XMP)	4GB ( 2x 2GB )	DS	-	-	7-7-7-24	1.6	•	
KINGMAX	FLGD45F-B8MF7(XMP)	1GB	SS	-	-	-	-	•	
KINGSTON	KHX1600C9D3K3/12GX(XMP)	12GB ( 3x 4GB )	DS	-	-	9	1.65	•	
KINGSTON	KHX1600C9D3K3/12GX(XMP)	12GB( 3x 4GB )	DS	-	-	-	1.65	•	
KINGSTON	KHX1600C9D3K6/24GX(XMP)	24GB ( 6x 4GB )	DS	-	-	9	1.65	•	
KINGSTON	KHX1600C8D3K2/4GX(XMP)	4GB ( 2x 2GB )	DS	-	-	8	1.65	•	
KINGSTON	KHX1600C9D3K2/4GX(XMP)	4GB ( 2x 2GB )	DS	-	-	-	1.65	•	
KINGSTON	KHX1600C9D3L2K/4GX(XMP)	4GB ( 2x 2GB )	DS	-	-	-	1.65	•	
KINGSTON	KHX1600C9D3X2K2/4GX(XMP)	4GB ( 2x 2GB )	DS	-	-	9	1.65	•	
KINGSTON	KHX1600C9D3K3/6GX(XMP)	6GB ( 3x 2GB )	DS	-	-	9	1.65	•	
KINGSTON	KHX1600C9D3K3/6GX(XMP)	6GB ( 3x 2GB )	DS	-	-	9	1.65	•	
KINGSTON	KHX1600C9D3T1K3/6GX(XMP)	6GB ( 3x 2GB )	DS	-	-	-	1.65	•	
KINGSTON	KHX1600C9D3T1K3/6GX(XMP)	6GB ( 3x 2GB )	DS	-	-	9	1.65	•	
KINGSTON	KHX1600C9D3P1K2/8G	8GB ( 2x 4GB )	DS	-	-	9	1.5	•	
OCZ	OCZ3BE1600CBLV4GK	4GB( 2x 2GB )	DS	-	-	8-8-8	1.65	•	
OCZ	OCZ3OB1600LV4GK	4GB(2 x 2GB)	DS	-	-	9-9-9	1.65	•	•
OCZ	OCZ3X1600LV6GK(XMP)	6GB(3 x 2GB)	DS	-	-	8-8-8	1.65	•	•
OCZ	OCZ3X1600LV6GK(XMP)	6GB(3 x 2GB)	DS	-	-	8-8-8	1.65	•	•
Super Talent	WP160UX4G9(XMP)	4GB(2 x 2GB)	DS	-	-	9	-	•	
Super Talent	WB160UX6G8(XMP)	6GB(3 x 2GB)	DS	-	-	-	-	•	
Super Talent	WB160UX6G8(XMP)	6GB(3 x 2GB)	DS	-	-	8	-	•	
Transcend	JM1600KLN-8GK	8GB ( 2x 4GB )	DS	Transcend	TK483PCW3	-	-	•	•
AEXEA	AXA3PS2G1600S18V(XMP)	2GB	DS	-	-	-	1.65	•	
Asint	SLZ3128M8-EGJ1D(XMP)	2GB	DS	Asint	3128M8-GJ1D	-	-	•	
EK Memory	EKM324L28BP8-116(XMP)	4GB( 2x 2GB )	DS	-	-	9	-	•	
EK Memory	EKM324L28BP8-116(XMP)	4GB(2 x 2GB)	DS	-	-	9	-	•	
GoodRam	GR1600D364L9/2G	2GB	DS	GoodRam	GF1008KC-JN	-	-	•	
KINGTIGER	KTG2G1600PG3(XMP)	2GB	DS	-	-	-	-	•	
Mushkin	998805(XMP)	4GB ( 2x 2GB )	DS	-	-	6-8-6-24	1.65	•	
Mushkin	998805(XMP)	6GB ( 3x 2GB )	DS	-	-	6-8-6-24	1.65	•	
Patriot	PX7312G1600LLK(XMP)	12GB ( 3x 4GB )	DS	-	-	8-9-8-24	1.65	•	
Patriot	PGS34G1600LLKA2	4GB ( 2x 2GB )	DS	-	-	8-8-8-24	1.7	•	
Patriot	PGS34G1600LLKA	4GB( 2x 2GB )	DS	-	-	7-7-7-20	1.7	•	
PATRIOT	PGS34G1600LLKA	4GB(2 x 2GB)	DS	-	-	7-7-7-20	1.7	•	
Patriot	PVV38G1600LLK(XMP)	8GB ( 2x 4GB )	DS	-	-	8-9-8-24	1.65	•	
Patriot	PXS38G1600LLK(XMP)	8GB ( 2x 4GB )	DS	-	-	8-9-8-24	1.65	•	
Team	TXD31024M1600C8-D(XMP)	1GB	SS	Team	T3D1288RT-16	8-8-8-24	1.65	•	
Team	TXD32048M1600C7-L(XMP)	2GB	DS	Team	T3D1288LT-16	7-7-7-24	1.65	•	
Team	TXD32048M1600HC8-D(XMP)	2GB	DS	Team	T3D1288RT-16	8-8-8-24	1.65	•	

## RAMPAGE IV FORMULA Motherboard Qualified Vendors Lists (QVL) DDR3 1800 MHz capability

Vendors	Part No.	Size	SS/DS	Chip Brand	Chip NO.	Timing	Voltage	DIMM socket support (Optional)	
								1 DIMM	4 DIMM
G.SKILL	F3-14400CL9D-4GBRL(XMP)	4GB(2 x 2GB)	DS	-	-	9-9-9-24	1.6	-	-

## RAMPAGE IV FORMULA Motherboard Qualified Vendors Lists (QVL) DDR3 1866 MHz capability

Vendors	Part No.	Size	SS/DS	Chip Brand	Chip NO.	Timing	Voltage	DIMM socket support (Optional)	
								1 DIMM	4 DIMM
A-DATA	AX3U1866GC2G9B(XMP)	2GB	SS	-	-	9-11-9-27	1.55-1.75	-	-
A-DATA	AX3U1866GC4G9B(XMP)	4GB	DS	-	-	9-11-9-27	1.55-1.75	-	-
CORSAIR	CM28GX3M2A1866C9(XMP)	8GB ( 2x 4GB )	DS	-	-	9-10-9-27	1.5	-	-
G.SKILL	F3-14900CL9Q-16GBXL(XMP)	16GB ( 4x 4GB )	DS	-	-	9-10-9-28	1.5	-	-
G.SKILL	F3-15000CL9D-4GBTD(XMP)	4GB(2 x 2GB)	DS	-	-	9-9-9-24	1.65	-	-
G.SKILL	F3-14900CL9D-8GBSR(XMP)	8GB ( 2x 4GB )	DS	-	-	9-10-9-28	1.5	-	-
G.SKILL	F3-14900CL9Q-8GBFLD(XMP)	8GB ( 2x 4GB )	DS	-	-	9-9-9-24	1.6	-	-
KINGSTON	KHX1866C9D3T1K3/GX(XMP)	3GB ( 3x 1GB )	SS	-	-	-	1.65	-	-
OCZ	OCZ3P1866C9LV6GK	6GB(3 x 2GB)	DS	-	-	9-9-9	1.65	-	-
OCZ	OCZ3RPR1866C9LV6GK	6GB(3 x 2GB)	DS	-	-	9-9-9	1.65	-	-
Patriot	PXD34G1866ELK(XMP)	4GB ( 2x 2GB )	SS	-	-	9-9-9-24	1.65	-	-
Patriot	PXD38G1866ELK(XMP)	8GB ( 2x 4GB )	DS	-	-	9-11-9-27	1.65	-	-
Team	TXD32048M1866C9(XMP)	2GB	DS	Team	T3D1288RT-16	9-9-9-24	1.65	-	-

## RAMPAGE IV FORMULA Motherboard Qualified Vendors Lists (QVL) DDR3 2000 MHz capability

Vendors	Part No.	Size	SS/DS	Chip Brand	Chip NO.	Timing	Voltage	DIMM socket support (Optional)	
								1 DIMM	4 DIMM
A-DATA	AX3U2000GB2G9B(XMP)	2GB	DS	-	-	9-11-9-27	1.55-1.75	-	-
A-DATA	AX3U2000GC4G9B(XMP)	4GB	DS	-	-	9-11-9-27	1.55-1.75	-	-
Apacer	78.AAGD5.9KD(XMP)	6GB(3 x 2GB)	DS	-	-	9-9-9-27	-	-	-
CORSAIR	CMT6GX3M3A2000C8(XMP)	6GB ( 3x 2GB )	DS	-	-	8-9-8-24	1.65	-	-
Crucial	BL12864BE2009.8SFB3(EPP)	1GB	SS	-	-	9-9-9-28	2	-	-
KINGSTON	KHX2000C9AD3T1K3/6GX(XMP)	6GB ( 3x 2GB )	DS	-	-	9	1.65	-	-
Transcend	TX2000KLN-8GK (888375)(XMP)	4GB	DS	-	-	-	1.6	-	-
AEXEA	AXA3ES2G2000LG28V(XMP)	2GB	DS	-	-	-	1.65	-	-
AEXEA	AXA3ES4GK2000LG28V(XMP)	4GB ( 2x 2GB )	DS	-	-	-	1.65	-	-
Gingie	FA3URSS673A801A	2GB	DS	-	-	9-9-9-24	-	-	-
Patriot	PX7312G2000ELK(XMP)	12GB ( 3x 4GB )	DS	-	-	9-11-9-27	1.65	-	-
Patriot	PV736G2000ELK(XMP)	6GB ( 3x 2GB )	DS	-	-	7-7-7-20	1.65	-	-
Patriot	PVT36G2000LLK(XMP)	6GB(3 x 2GB)	DS	-	-	8-8-8-24	1.65	-	-
Silicon Power	SP002GBLYU2000S02(XMP)	2GB	DS	-	-	-	-	-	-
Team	TXD32048M2000C9(XMP)	2GB	DS	Team	T3D1288RT-20	9-9-9-24	1.5	-	-
Team	TXD32048M2000C9-L(XMP)	2GB	DS	Team	T3D1288LT-20	9-9-9-24	1.5	-	-
Team	TXD32048M2000C9-L(XMP)	2GB	DS	Team	T3D1288RT-20	9-9-9-24	1.6	-	-

## RAMPAGE IV FORMULA Motherboard Qualified Vendors Lists (QVL) DDR3 2133 MHz capability

Vendors	Part No.	Size	SS/DS	Chip Brand	Chip NO.	Timing	Voltage	DIMM socket support (Optional)	
								1 DIMM	4 DIMM
A-DATA	8154A 1044(XMP)	2GB	SS	-	-	9-9-9-24	1.55-1.75	-	-
A-DATA	AX3U2133C2G9B(XMP)	2GB	SS	-	-	9-11-9-27	1.55-1.75	-	-
A-DATA	AX3U2133C2G9B(XMP)	2GB	SS	-	-	9-9-9-24	1.55-1.75	-	-
Apacer	78.BAGE4.AFD0C(XMP)	8GB ( 2x 4GB )	DS	-	-	9-9-9-24	-	-	-
CORSAIR	CMT4GX3M2A2133C9(XMP)	4GB ( 2x 2GB )	DS	-	-	9-10-9-24	1.65	-	-
CORSAIR	CMT4GX3M2B2133C9(XMP)	4GB ( 2x 2GB )	DS	-	-	9-10-9-27	1.5	-	-
G.SKILL	F3-17000CL9Q-16GBXLD(XMP)	16GB ( 4x 4GB )	DS	-	-	9-11-9-28	1.65	-	-
G.SKILL	F3-17066CL9Q-16GBTDD(XMP)	16GB ( 4x 4GB )	DS	-	-	9-9-9-24	1.65	-	-
G.SKILL	F3-17066CL9D-8GBPID(XMP)	8GB ( 2x 4GB )	DS	-	-	9-9-9-24	1.65	-	-
GEIL	GE34GB2133C9DC(XMP)	4GB(2 x 2GB)	DS	-	-	9-9-9-28	1.65	-	-
KINGSTON	KHX2133C9AD3T1K2/4GX(XMP)	4GB ( 2x 2GB )	DS	-	-	-	1.65	-	-
KINGSTON	KHX2133C9AD3T1K2/4GX(XMP)	4GB ( 2x 2GB )	DS	-	-	9	1.65	-	-
KINGSTON	KHX2133C9AD3K1W1K2/4GX(XMP)	4GB ( 2x 2GB )	DS	-	-	9	1.65	-	-
KINGSTON	KHX2133C9AD3X2K2/4GX(XMP)	4GB ( 2x 2GB )	DS	-	-	9	1.65	-	-
KINGSTON	KHX2133C9AD3X2K2/4GX(XMP)	4GB ( 2x 2GB )	DS	-	-	9-9-9-24	1.65	-	-
KINGSTON	KHX2133C9AD3T1FK4/8GX(XMP)	8GB ( 4x 2GB )	DS	-	-	9	1.65	-	-
OCZ	OCZ3XTEP2133C9LV4GK	2GB	DS	-	-	7-7-7-20	1.65	-	-
Patriot	PVV34G2133C9K(XMP)	4GB ( 2x 2GB )	DS	-	-	9-11-9-27	1.66	-	-

## RAMPAGE IV FORMULA Motherboard Qualified Vendors Lists (QVL) DDR3 2200 MHz capability

Vendors	Part No.	Size	SS/DS	Chip Brand	Chip NO.	Timing	Voltage	DIMM socket support (Optional)	
								1 DIMM	4 DIMM
G.SKILL	F3-17600CL7D-4GBFLS(XMP)	4G ( 2x 2G )	DS	-	-	7-10-10-28	1.65	-	-
G.SKILL	F3-17600CL8D-4GBPS(XMP)	4GB(2 x 2GB)	DS	-	-	8-8-8-24	1.65	-	-
G.SKILL	F3-17600CL9D-4GBTDS(XMP)	4GB(2 x 2GB)	DS	-	-	9-9-9-24	1.65	-	-
GEIL	GET34GB2200C9DC(XMP)	4GB ( 2x 2GB )	DS	-	-	9-10-9-28	1.65	-	-
GEIL	GET38GB2200C9ADC(XMP)	8GB ( 2x 4GB )	DS	-	-	9-11-9-28	1.65	-	-
KINGMAX	FLKE85F-B8KHA(XMP)	4G ( 2x 2G )	DS	-	-	-	1.5-1.7	-	-
KINGMAX	FLKE85F-B8KJAA-FEIS(XMP)	4GB ( 2x 2GB )	DS	Kingmax	N/A	-	-	-	-

## RAMPAGE IV FORMULA Motherboard Qualified Vendors Lists (QVL) DDR3 2400 MHz capability

Vendors	Part No.	Size	SS/DS	Chip Brand	Chip NO.	Timing	Voltage	DIMM socket support (Optional)		
								1 DIMM	2 DIMM	4 DIMM
A-DATA	AX3U2400G4G10(XMP)	4GB	DS	-	-	10-11-10-30	1.65	-	-	
CORSAIR	CMGTX8(XMP)	8GB ( 4x 2GB )	SS	-	-	10-12-10-30	1.65	-	-	
CORSAIR	CMGTX3(XMP)	2GB	DS	-	-	9-11-9-27	1.65	-	-	
G.Skill	F3-19200CL11Q-16GBZH(XMP)	16GB ( 4x 4GB )	DS	-	-	11-11-11-31	1.65	-	-	
GEIL	GOC316GB2400C11QC(XMP)	16GB ( 4x 4GB )	DS	-	-	11-11-11-30	1.65	-	-	
Transcend	TX2400KLU-4GK (381850)(XMP)	2GB	DS	-	-	-	1.65	-	-	
Transcend	TX2400KLU-4GK(374243)(XMP)	2GB	DS	-	-	-	1.65	-	-	
Patriot	PVV34G2400C9K(XMP)	4GB ( 2x 2GB )	DS	-	-	9-11-9-27	1.66	-	-	

## 2.2.4 Expansion slots



Ensure to unplug the power cord before adding or removing expansion cards. Failure to do so may cause you physical injury and damage motherboard components.

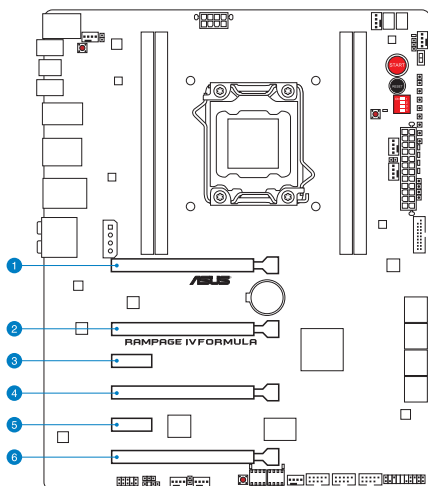

Slot No.	Slot Description
1	PCIe 3.0 x16_1 slot
2	PCIe 3.0 x8_2 slot
3	PCIe 2.0 x1_1 slot
4	PCIe 3.0 x16/8_3 slot
5	PCIe 2.0 x1_2 slot
6	PCIe 3.0 x8_4 slot



- Refer to the following configuration table for installation.

PCIe x16 Slot #	Single VGA	SLI/CF	3-way SLI/CFX	Quad SLI/CFX
1	x16	x16	x16	x16
2	—	—	x8	x8
4	—	x16	x16	x8
6	—	—	—	x8

- We recommend that you provide sufficient power when running CrossFireX™ or SLI mode. See page 2-34 for details.
- While running at heavy loaded four VGA cards, ensure to plug in the 6-pin extra PCIe power supply for stability.
- Connect a chassis fan to the motherboard connector labeled CHA\_FAN1/2/3 when using multiple graphics cards for better thermal environment.



## IRQ assignments for this motherboard

	A	B	C	D	E	F	G	H
PCIEX16_1	shared	-	-	-	-	-	-	-
PCIEX8_2	shared	-	-	-	-	-	-	-
PCIEX16/X8_3	shared	-	-	-	-	-	-	-
PCIEX8_4	shared	-	-	-	-	-	-	-
PCIEX1_1	shared	-	-	-	-	-	-	-
PCIEX1_2	-	shared	-	-	-	-	-	-
ASM USB3#1	-	shared	-	-	-	-	-	-
ASM USB3#2	-	-	-	shared	-	-	-	-
ASM USB3#3	shared	-	-	-	-	-	-	-
ASM SATA6#1	-	shared	-	-	-	-	-	-
Intel 82579V	-	-	shared	-	-	-	-	-
ASM SATA6#2	-	-	-	shared	-	-	-	-
EHCI#0	-	-	-	-	-	-	-	shared
EHCI#1	-	-	-	-	-	shared	-	-
High Definition Audio	-	-	-	-	-	-	shared	-
SATA #0	-	-	shared	-	-	-	-	-
SATA #0	-	-	-	-	shared	-	-	-

## 2.2.5 Onboard switches

Onboard switches allow you to fine-tune performance when working on a bare or open-case system. This is ideal for overclockers and gamers who continually change settings to enhance system performance.

### 1. Power-on switch

Press the power-on switch to wake/power up the system.

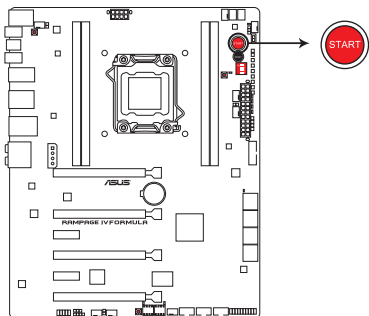

**RAMPAGE IV FORMULA Power on Switch**

### 2. Reset switch

Press the reset switch to reboot the system.

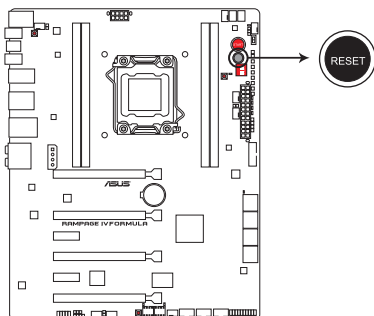

**RAMPAGE IV FORMULA Reset Switch**

### 3. GO button

Press the GO button before POST to enable MemOK! or press it to quickly load the preset profile (GO\_Button file) for temporary overclocking when in OS.

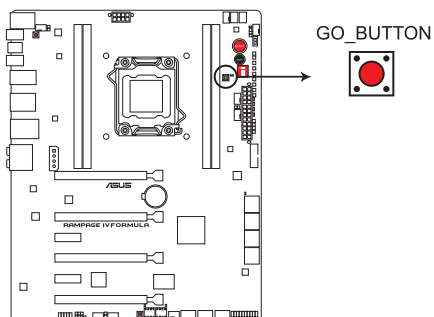

**RAMPAGE IV FORMULA GO BUTTON**

### 4. BIOS button

The motherboard comes with two BIOS. Press the BIOS button to switch BIOS and load different BIOS settings. The nearby BIOS LEDs indicate the BIOS you are using.

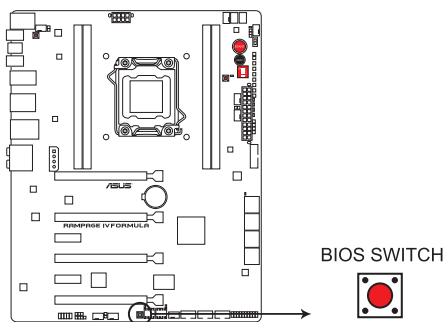

**RAMPAGE IV FORMULA BIOS Switch**

## 5. PCIe x16 Lane switch

These slide switches allows you to enable and disable the corresponding PCIe x16 slots. When one of the installed PCIe x16 cards is out of order, you can use the slide switch to find out the faulty one without removing the cards.

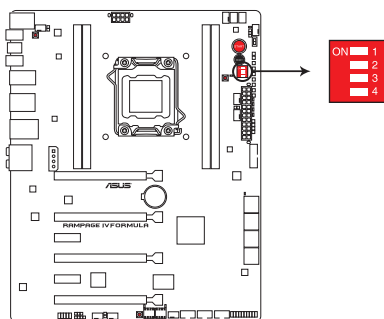

**RAMPAGE IV FORMULA PCIe x16 Lane Switch**

## 6. Q reset button

If the LN2\_Mode jumper does not work and your CPU cannot resume function, press the Q reset button to temporarily stop the power supply to the CPU and help the CPU recover from a frozen condition.

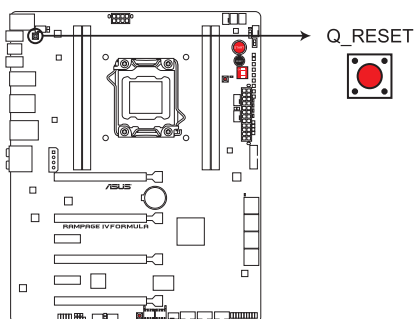

**RAMPAGE IV FORMULA Q\_RESET Switch**

## 7. Slow Mode Switch

Slow Mode Switch is employed during LN2 benching. Some processors have a small optimum temperature range to run at their highest frequency. Warmer or colder yields instability at this frequency. For example, a certain processor may need  $-80^{\circ}\text{C}$  loaded in order to run 5.8GHz, which means about  $-75^{\circ}\text{C}$  idle in order to stay stable at 5.8GHz.

Going colder or warmer crashes. It will however remain stable at slower frequencies at much colder or warmer temperatures. Once it comes out of a heavy load while transitioning over to a light load, when the temperature does not warm fast enough, it may crash. To over-come this simply flip the switch over to "slow" the processor instantaneously. Switching over to Slow-Mode during critical moments when Temperature/Max Frequency alignment is off-synch saves you a lot of crashes, even when trying to boot into the OS at cold temperatures.

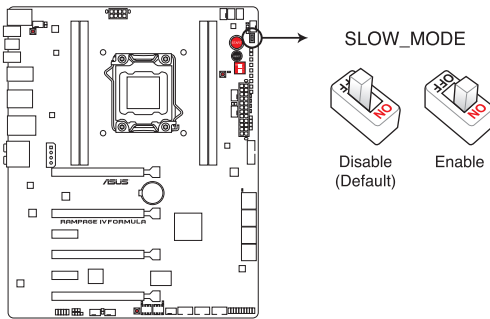

**RAMPAGE IV FORMULA Slow Mode Switch**



The Slow mode switch is workable only when LN2 mode jumper is set to enable. (please see 2-26)

## 2.2.6 Onboard LEDs

The motherboard comes with a set of LEDs that indicate the voltage conditions of CPU, memory, northbridge and southbridge. You may adjust the voltages in BIOS. There are also an LED for hard disk drive activity and an onboard switch for power status. For more information about voltage adjustment, refer to **3.3 Extreme Tweaker menu**.

### 1. Voltiminder LED II

Voltiminder LED II provides not only many measurement spots for various voltages but LEDs indicating which voltage is being polled. This is especially useful when debugging overclock failures. Voltiminder LED II consists of the following LED set: **DRAM\_CD**, **DRAM\_AB**, **PCH\_1.5V**, **PCH\_1.1V**, **CPU\_PLL**, **CPU\_VTT**, **CPU\_VSA**, **CPU\_GND\_U** and **CPU\_FREQ**. For example, when you fail to post and see the LED for CPU\_VTT light up, it tells you that your system does not like the setting for CPU VTT.

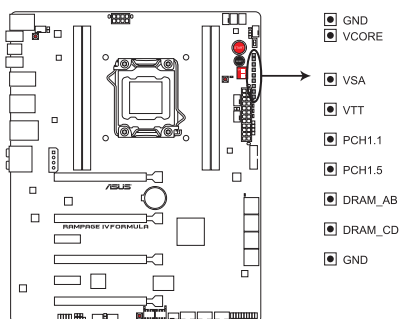

**RAMPAGE IV FORMULA Voltiminder LED II/Probel**

## 2. Hard Disk LED

The hard disk LED is designed to indicate the hard disk activity. It blinks when data is being written into or read from the hard disk drive. The LED does not light up when there is no hard disk drive connected to the motherboard or when the hard disk drive does not function.

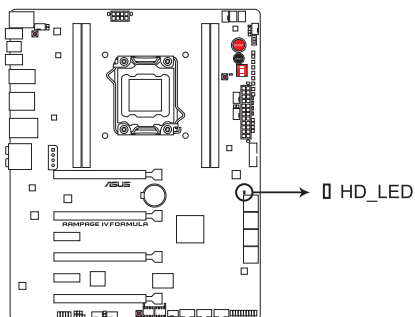

**RAMPAGE IV FORMULA Hard Disk LED**

## 3. BIOS LED

The BIOS LEDs help indicate the BIOS activity. Press the BIOS button to switch between BIOS1 and BIOS2 and the LED lights up when the corresponding BIOS is in use.

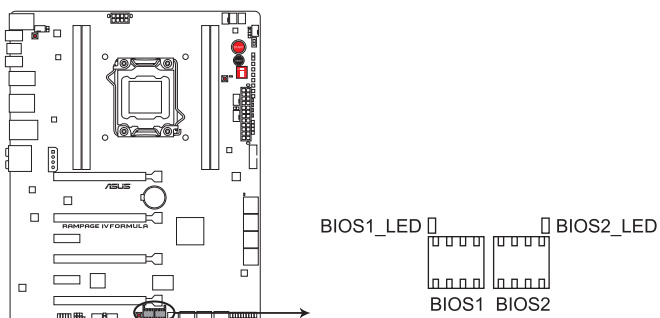

**RAMPAGE IV FORMULA BIOS LED**

#### 4. GO LED

**Blinking:** Indicates that MemOK! is enabled before POST.

**Lighting:** Indicates that the system loads the preset profile (GO\_Button file) for temporary overlocking when in OS.

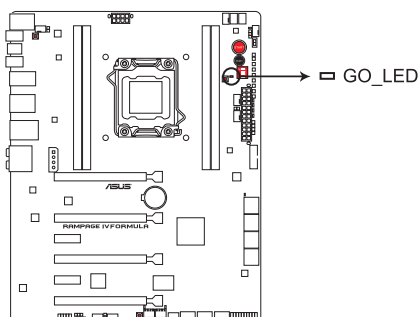

**RAMPAGE IV FORMULA GO LED**

#### 5. Q LED

Q LEDs check key components (CPU, DRAM, VGA card, and booting devices) in sequence during motherboard booting process. If an error is found, the corresponding LED will continue lighting until the problem is solved. This user-friendly design provides an intuitional way to locate the root problem within a second.

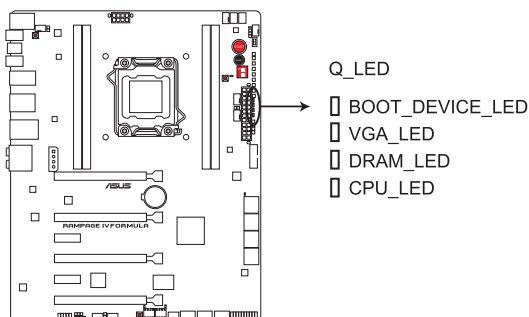

**RAMPAGE IV FORMULA Q LED**



## 6. Power LED

The motherboard comes with a power-on switch that lights up to indicate that the system is ON, in sleep mode, or in soft-off mode. This is a reminder that you should shut down the system and unplug the power cable before removing or plugging in any motherboard component. The illustration below shows the location of the onboard power-on switch.

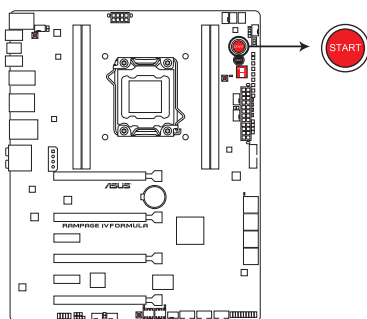

**RAMPAGE IV FORMULA Power on Switch**

## 7. Debug LEDs

The Debug LED design provides you the 2-digit display, allowing you to know the system status. Refer to the Debug table below for details.

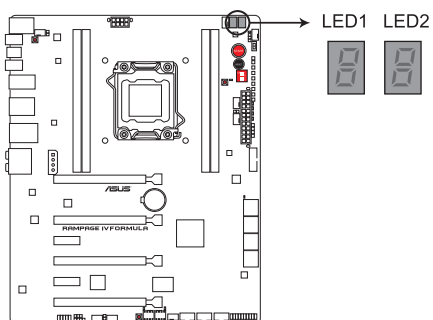

**RAMPAGE IV FORMULA Debug LEDs**

## Debug table

Code	Description
00	Not used
01	Power on. Reset type detection (soft/hard).
02	AP initialization before microcode loading
03	System Agent initialization before microcode loading
04	PCH initialization before microcode loading
05	OEM initialization before microcode loading
06	Microcode loading
07	AP initialization after microcode loading
08	System Agent initialization after microcode loading
09	PCH initialization after microcode loading
0A	OEM initialization after microcode loading
0B	Cache initialization
0C – 0D	Reserved for future AMI SEC error codes
0E	Microcode not found
0F	Microcode not loaded
10	PEI Core is started
11 – 14	Pre-memory CPU initialization is started
15 – 18	Pre-memory System Agent initialization is started
19 – 1C	Pre-memory PCH initialization is started
1D – 2A	OEM pre-memory initialization codes
2B – 2F	Memory initialization
30	Reserved for ASL (see ASL Status Codes section below)
31	Memory Installed
32 – 36	CPU post-memory initialization
37 – 3A	Post-Memory System Agent initialization is started

## Debug table (continued)

Code	Description
3B – 3E	Post-Memory PCH initialization is started
3F – 4E	OEM post memory initialization codes
4F	DXE IPL is started
50 – 53	Memory initialization error. Invalid memory type or incompatible memory speed
54	Unspecified memory initialization error
55	Memory not installed
56	Invalid CPU type or Speed
57	CPU mismatch
58	CPU self test failed or possible CPU cache error
59	CPU micro-code is not found or micro-code update is failed
5A	Internal CPU error
5B	Reset PPI is not available
5C – 5F	Reserved for future AMI error codes
E0	S3 Resume is started (S3 Resume PPI is called by the DXE IPL)
E1	S3 Boot Script execution
E2	Video repost
E3	OS S3 wake vector call
E4 – E7	Reserved for future AMI progress codes
E8	S3 Resume Failed
E9	S3 Resume PPI not Found
EA	S3 Resume Boot Script Error
EB	S3 OS Wake Error
EC – EF	Reserved for future AMI error codes
F0	Recovery condition triggered by firmware (Auto recovery)
F1	Recovery condition triggered by user (Forced recovery)
F2	Recovery process started
F3	Recovery firmware image is found
F4	Recovery firmware image is loaded
F5-F7	Reserved for future AMI progress codes
F8	Recovery PPI is not available
F9	Recovery capsule is not found
FA	Invalid recovery capsule
FB-FF	Reserved for future AMI error codes
60	DXE Core is started
61	NVRAM initialization
62	Installation of the PCH Runtime Services
63 – 67	CPU DXE initialization is started
68	PCI host bridge initialization
69	System Agent DXE initialization is started
6A	System Agent DXE SMM initialization is started
6B – 6F	System Agent DXE initialization (System Agent module specific)
70	PCH DXE initialization is started

## Debug table (continued)

Code	Description
71	PCH DXE SMM initialization is started
72	PCH devices initialization
73 – 77	PCH DXE Initialization (PCH module specific)
78	ACPI module initialization
79	CSM initialization
7A – 7F	Reserved for future AMI DXE codes
80 – 8F	OEM DXE initialization codes
90	Boot Device Selection (BDS) phase is started
91	Driver connecting is started
92	PCI Bus initialization is started
93	PCI Bus Hot Plug Controller Initialization
94	PCI Bus Enumeration
95	PCI Bus Request Resources
96	PCI Bus Assign Resources
97	Console Output devices connect
98	Console input devices connect
99	Super IO Initialization
9A	USB initialization is started
9B	USB Reset
9C	USB Detect
9D	USB Enable
9E – 9F	Reserved for future AMI codes
A0	IDE initialization is started
A1	IDE Reset
A2	IDE Detect
A3	IDE Enable
A4	SCSI initialization is started
A5	SCSI Reset
A6	SCSI Detect
A7	SCSI Enable
A8	Setup Verifying Password
A9	Start of Setup
AA	Reserved for ASL (see ASL Status Codes section below)*
AB	Setup Input Wait
AC	Reserved for ASL (see ASL Status Codes section below)
AD	Ready To Boot event
AE	Legacy Boot event
AF	Exit Boot Services event
B0	Runtime Set Virtual Address MAP Begin
B1	Runtime Set Virtual Address MAP End
B2	Legacy Option ROM Initialization
B3	System Reset

**Debug table (continued)**

Code	Description
B4	USB hot plug
B5	PCI bus hot plug
B6	Clean-up of NVRAM
B7	Configuration Reset (reset of NVRAM settings)
B8– BF	Reserved for future AMI codes
C0– CF	OEM BDS initialization codes
D0	CPU initialization error
D1	System Agent initialization error
D2	PCH initialization error
D3	Some of the Architectural Protocols are not available
D4	PCI resource allocation error. Out of Resources
D5	No Space for Legacy Option ROM
D6	No Console Output Devices are found
D7	No Console Input Devices are found
D8	Invalid password
D9	Error loading Boot Option (LoadImage returned error)
DA	Boot Option is failed (StartImage returned error)
DB	Flash update is failed
DC	Reset protocol is not available

**\*ASL Status Codes**

Status Code	Description
01	System is entering S1 sleep state
02	System is entering S2 sleep state
03	System is entering S3 sleep state
04	System is entering S4 sleep state
05	System is entering S5 sleep state
10	System is waking up from the S1 sleep state
20	System is waking up from the S2 sleep state
30	System is waking up from the S3 sleep state
40	System is waking up from the S4 sleep state
AC	System has transitioned into ACPI mode. Interrupt controller is in APIC mode
AA	System has transitioned into ACPI mode. Interrupt controller is in APIC mode

## 2.2.7 Jumper

### 1. LN2 Mode Jumper (3-pin LN2)

With LN2 mode activated, the ROG motherboard is optimized to remedy the cold-boot bug during POST at an extremely low temperature and help the system boot successfully.

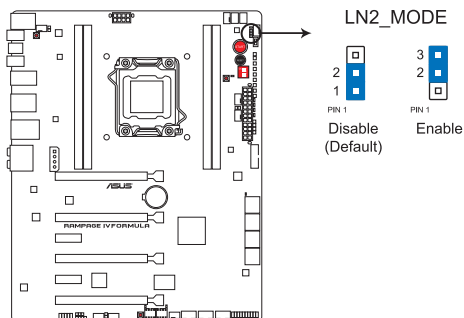

RAMPAGE IV FORMULA LN2 MODE

## 2.2.8 Internal connectors

### 1. Intel® X79 Serial ATA 6.0 Gb/s connectors (7-pin SATA6G\_1/2 [red])

These connectors connect to Serial ATA 6.0 Gb/s hard disk drives via Serial ATA 6.0 Gb/s signal cables.

If you installed Serial ATA hard disk drives, you can create a RAID 0, 1, 5, and 10 configuration with the Intel® Rapid Storage Technology through the onboard Intel® X79 chipset.

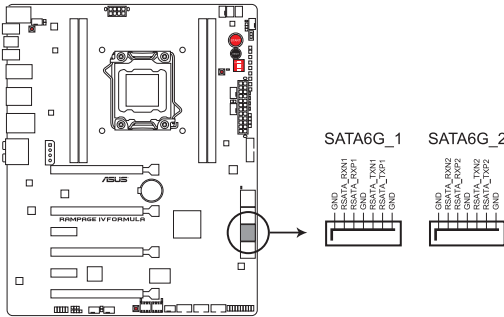

**RAMPAGE IV FORMULA Intel® SATA 6.0 Gb/s connectors**



- These connectors are set to [AHCI Mode] by default. If you intend to create a Serial ATA RAID set using these connectors, set the **SATA Mode** item in the BIOS to [RAID Mode]. Refer to section **3.5.4 SATA Configuration** for details.
- Before creating a RAID set, refer to section **4.4 RAID configurations** or the manual bundled in the motherboard support DVD.
- When using NCQ, set the **SATA Mode** in the BIOS to [AHCI Mode]. Refer to section **3.5.4 SATA Configuration** for details.
- You must install Windows® XP Service Pack 3 or later versions before using Serial ATA RAID drives. The Serial ATA RAID feature is available only if you are using Windows® XP SP3 or later versions.

## 2. Intel® X79 Serial ATA 3.0 Gb/s connectors (7-pin SATA3G\_1–4 [black])

These connectors connect to Serial ATA 3.0 Gb/s hard disk drives and optical disc drives via Serial ATA 3.0 Gb/s signal cables.

If you installed Serial ATA hard disk drives, you can create a RAID 0, 1, 5, and 10 configuration with the Intel® Rapid Storage Technology through the onboard Intel® X79 chipset.

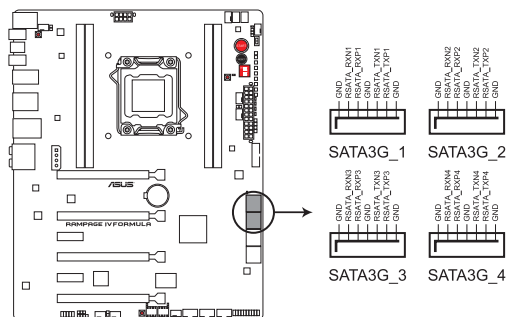

RAMPAGE IV FORMULA Intel® SATA 3.0 Gb/s connectors

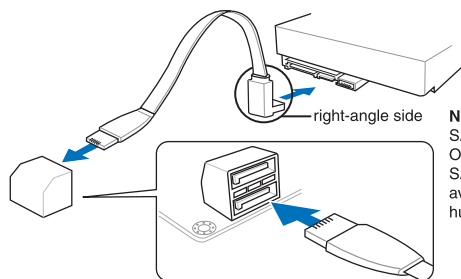

**NOTE:** Connect the right-angle side of SATA signal cable to SATA device.  
Or you may connect the right-angle side of SATA cable to the onboard SATA port to avoid mechanical conflict with huge graphics cards.



- These connectors are set to [AHCI Mode] by default. If you intend to create a Serial ATA RAID set using these connectors, set the **SATA Mode** item in the BIOS to [RAID Mode]. Refer to section 3.5.4 **SATA Configuration** for details.
- Before creating a RAID set, refer to section 4.4 **RAID configurations** or the manual bundled in the motherboard support DVD.
- When using NCQ, set the **SATA Mode** in the BIOS to [AHCI Mode]. Refer to section 3.5.4 **SATA Configuration** for details.
- You must install Windows® XP Service Pack 3 or later versions before using Serial ATA hard disk drives. The Serial ATA RAID feature is available only if you are using Windows® XP SP3 or later versions.



### 3. ASMedia® Serial ATA 6.0 Gb/s connectors (7-pin SATA6G\_E1/E2 [red])

These connectors connect to Serial ATA 6.0 Gb/s hard disk drives via Serial ATA 6.0 Gb/s signal cables.

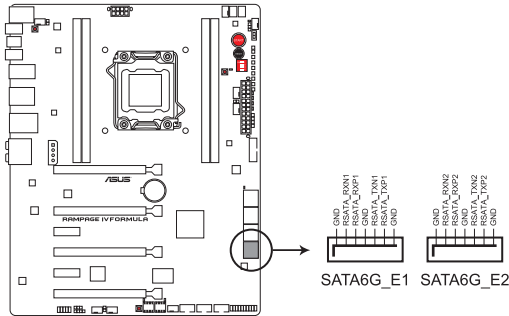

**RAMPAGE IV FORMULA ASMedia SATA 6.0 Gb/s connectors**



- The SATA6G\_E1/E2 (red) connectors are for data drives only. ATAPI device is not supported.
- You must install Windows® XP Service Pack 3 or later versions before using Serial ATA hard disk drives.
- When using NCQ, set the **ASM1061 Storage Controller** item in the BIOS to [ACHI]. Refer to section **3.5.6 Onboard Devices Configuration** for details.

#### 4. USB 3.0 connector (20-pin USB3\_56)

This connector is for the additional USB 3.0 ports, and complies with the USB 3.0 specification that supports up to 4.8Gbps connection speed. If the USB 3.0 front panel cable is available from your system chassis, with this USB 3.0 connector, you can have a front panel USB 3.0 solution.

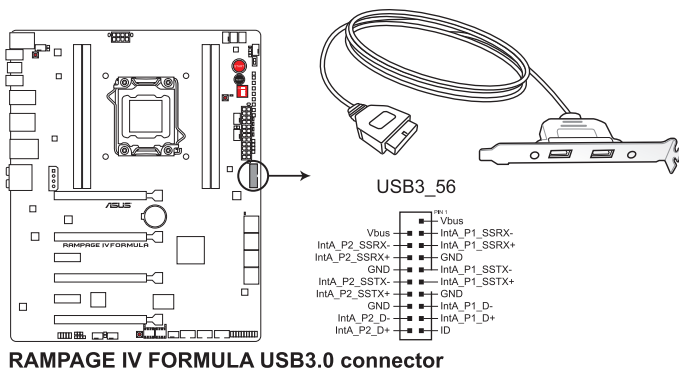

The USB 3.0 module is purchased separately.

#### 5. Thermal sensor cable connectors (2-pin OPT\_TEMP1/2/3)

These connectors are for temperature monitoring. Connect the thermal sensor cables to these connectors and place the other ends to the devices which you want to monitor temperature. The optional fan1/2/3 can work with the temperature sensors for a better cooling effect.

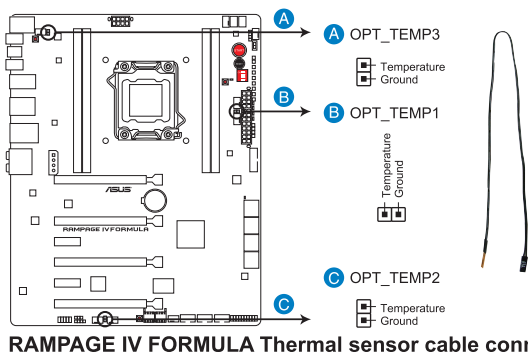

Enable **OPT FAN1/2/3** **overheat protection** in BIOS if you connect thermal sensor cables to these connectors.



The thermal sensor cables are purchased separately.

## 6. USB 2.0 connectors (10-1 pin USB78; USB910; USB1112)

These connectors are for USB 2.0 ports. Connect the USB module cable to any of these connectors, then install the module to a slot opening at the back of the system chassis. These USB connectors comply with USB 2.0 specification that supports up to 480 Mbps connection speed.

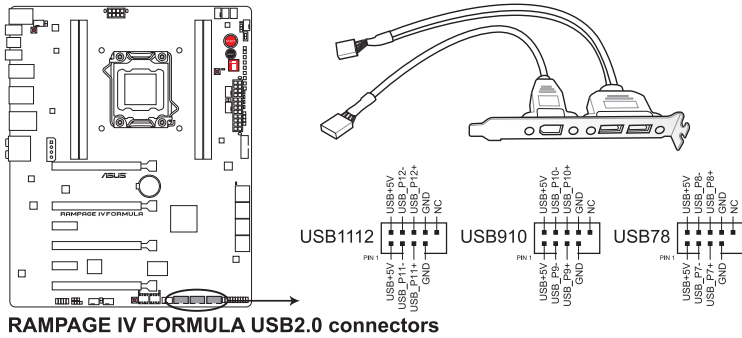

Never connect a 1394 cable to the USB connectors. Doing so will damage the motherboard!



You can connect the front panel USB cable to the ASUS Q-Connector (USB, blue) first, and then install the Q-Connector (USB) to the USB connector onboard if your chassis supports front panel USB ports.



The USB 2.0 module is purchased separately.

## 7. Digital audio connector (4-1 pin SPDIF\_OUT)

This connector is for an additional Sony/Philips Digital Interface (S/PDIF) port. Connect the S/PDIF Out module cable to this connector, then install the module to a slot opening at the back of the system chassis.

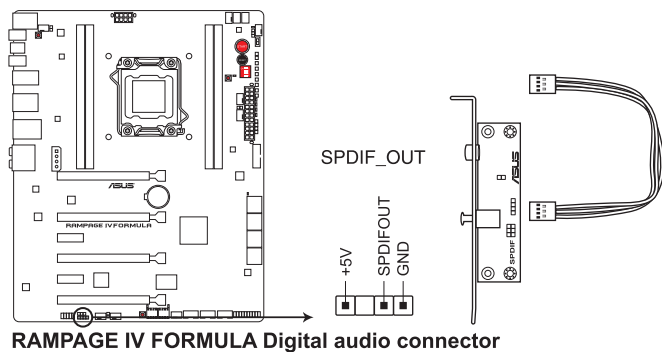

---

The S/PDIF module is purchased separately.

---

## 8. CPU, chassis, and power fan connectors (4-pin CPU\_FAN; 4-pin CPU\_OPT; 4-pin CHA\_FAN1/2/3; 4-pin OPT\_FAN1/2/3)

Connect the fan cables to the fan connectors on the motherboard, ensuring that the black wire of each cable matches the ground pin of the connector.

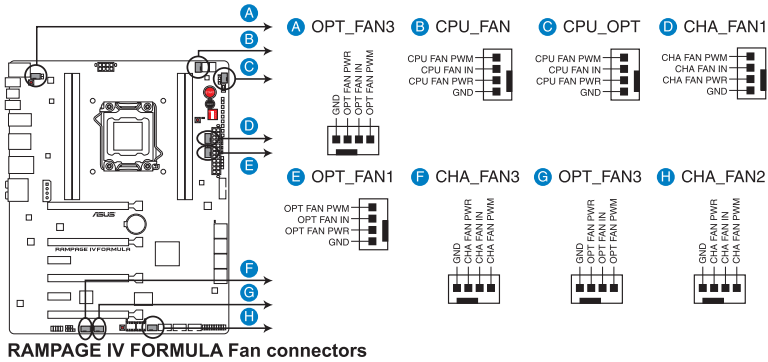

Do not forget to connect the fan cables to the fan connectors. Insufficient air flow inside the system may damage the motherboard components. These are not jumpers! Do not place jumper caps on the fan connectors!



- The CPU\_FAN connector supports the CPU fan of maximum 1A (12 W) fan power.
- Only the CPU\_FAN, CHA\_FAN 1, CHA\_FAN 2 and CHA\_FAN 3 connectors support the ASUS FAN Xpert feature.
- If you install two VGA cards, we recommend that you plug the rear chassis fan cable to the motherboard connector labeled CHA\_FAN1 or CHA\_FAN2 for better thermal environment.

## 9. Front panel audio connector (10-1 pin AAFP)

This connector is for a chassis-mounted front panel audio I/O module that supports either HD Audio or legacy AC '97 audio standard. Connect one end of the front panel audio I/O module cable to this connector.

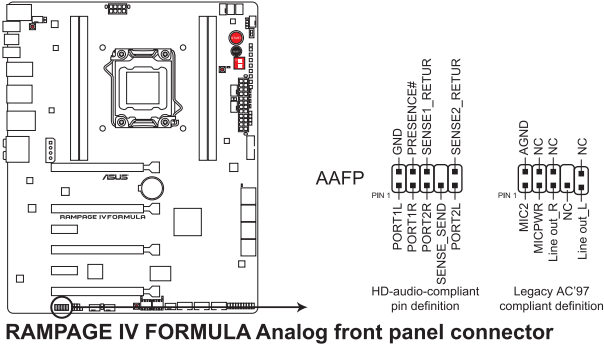

- We recommend that you connect a high-definition front panel audio module to this connector to avail of the motherboard's high-definition audio capability.
- If you want to connect a high-definition front panel audio module to this connector, set the **Front Panel Type** item in the BIOS setup to **[HD]**; if you want to connect an AC'97 front panel audio module to this connector, set the item to **[AC97]**. By default, this connector is set to **[HD]**.

## 10. ATX power connectors (24-pin EATXPWR; 8-pin EATX12V)

These connectors are for ATX power supply plugs. The power supply plugs are designed to fit these connectors in only one orientation. Find the proper orientation and push down firmly until the connectors completely fit.

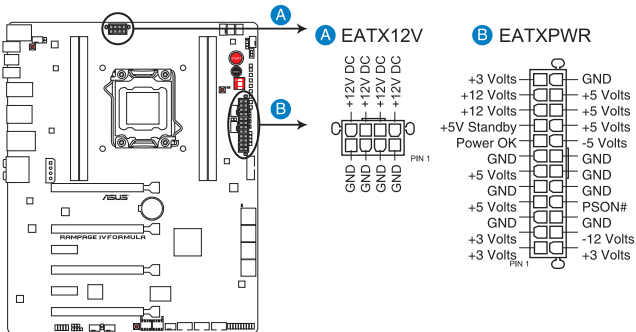



- For a fully configured system, we recommend that you use a power supply unit (PSU) that complies with ATX 12 V Specification 2.0 (or later version) and provides a minimum power of 350 W.
- Do not forget to connect the 8-pin EATX12 V power plug; otherwise, the system will not boot.
- Use of a PSU with a higher power output is recommended when configuring a system with more power-consuming devices. The system may become unstable or may not boot up if the power is inadequate.
- If you want to use two or more high-end PCI Express x16 cards, use a PSU with 1000W power or above to ensure the system stability.
- If you are uncertain about the minimum power supply requirement for your system, refer to the Recommended Power Supply Wattage Calculator at <http://support.asus.com/PowerSupplyCalculator/PSCalculator.aspx?SLanguage=en-us> for details.

#### PSU Suggested List

AcBel PC7030	Gigabyte P610A-C1
AcBel API5PC36	GoldenField ATX-S398
AcBel PC6018	GoldenField ATX-S550
AMA AA1200U-C	GreatWall BTX-600SE
AMA AA1000U-C	HECHUAN ST-ATX330
Antec SG-850	Huntkey R85
Antec EA-380	Huntkey 磐石500
ASUS P-50GA	I-cute AP-600S
ASUS P-55GA	In-Win COMMANDER-IRP-COM1500
ASUS U-65GA	OCZ 1000PXS
ASUS U-75HA	OCZ 780MXS
Be quiet BN073	SAMA YUHUI-350P
Be quiet BN077	Seasonic SS-500GB
Be quiet P6-PRO-850W	Seasonic SS-850EM
Bubalus PE600WJD	Seasonic SS-900HP
CoolerMaster RS-650	Seventeam ST-420BKP
CoolerMaster RS-750	Seventeam ST-522HLP
CoolerMaster RS-850EMBA	Seventeam ST550EAJ-05F
CoolerMaster RS-A00-ESBA	SHARKOON SHA-R600M
CoolerMaster RS-C50-EMBA-D2	Silverstone SST-ST50EF
Coolive AP-350F	Silverstone SST-ST85F
Corsair CMPSU-550VX	Silverstone ST1000
Corsair CMPSU-620HX	Snake PSH500V
Corsair CMPSU-750TX	Snake PSH850V
CWT PSH650V-D	Snake PMW-350WL
CWT PSH750V-D	Tagan TG1100-U33
Delta GPS-550AB	Tagan BZ11200
EnerMAX EPG600AWT	Thermaltake W0133RU
EnerMAX EGX1000EWL	Thermaltake W0133RE
EnerMAX EIN720AWT	TOPower TOP-500P5
FSP ATX-300PNR	Zalman ZM600-HP
Gigabyte M550A-D1	Zippy HP2-6500PE (G1)

**11. EZ Plug connector (4-pin EZ\_PLUG)**

This 4-pin connector is for VGA power supply plug. Find the proper orientation and push down firmly until the connectors completely fit.

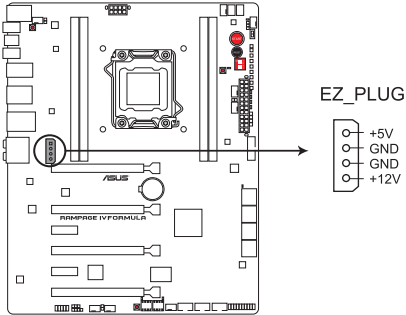

**RAMPAGE IV FORMULA EZ\_PLUG**



## 12. System panel connector (20-8 pin PANEL)

This connector supports several chassis-mounted functions.

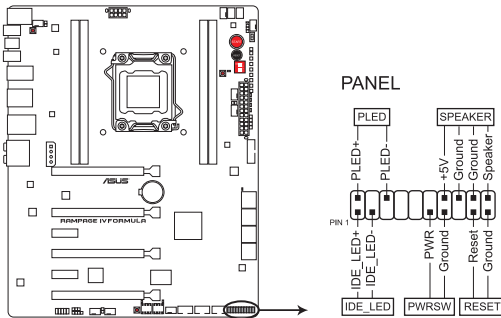

**RAMPAGE IV FORMULA**  
System panel connector

- **System power LED (2-pin PLED)**

This 2-pin connector is for the system power LED. Connect the chassis power LED cable to this connector. The system power LED lights up when you turn on the system power, and blinks when the system is in sleep mode.

- **Hard disk drive activity LED (2-pin IDE\_LED)**

This 2-pin connector is for the HDD Activity LED. Connect the HDD Activity LED cable to this connector. The IDE LED lights up or flashes when data is read from or written to the HDD.

- **System warning speaker (4-pin SPEAKER)**

This 4-pin connector is for the chassis-mounted system warning speaker. The speaker allows you to hear system beeps and warnings.

- **ATX power button/soft-off button (2-pin PWRSW)**





This connector is for the system power button. Pressing the power button turns the system on or puts the system in sleep or soft-off mode depending on the BIOS settings. Pressing the power switch for more than four seconds while the system is ON turns the system OFF.

- **Reset button (2-pin RESET)**

This 2-pin connector is for the chassis-mounted reset button for system reboot without turning off the system power.

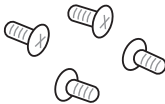
## 2.3 Building your computer system

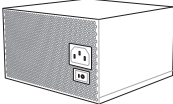
### 2.3.1 Additional tools and components to build a PC system

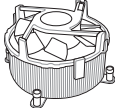
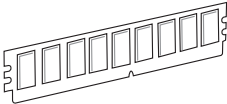
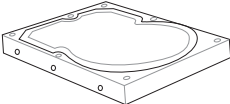
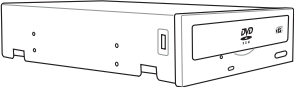
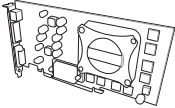
	
1 bag of screws	Philips (cross) screwdriver
	
PC chassis	Power supply unit
	
Intel LGA 2011 CPU	Intel LGA 2011 compatible CPU Fan
	
DIMM	SATA hard disk drive
	
SATA optical disc drive (optional)	Graphics card



The tools and components in the table above are not included in the motherboard package.

### 2.3.2 CPU installation



Please note the order in opening/ closing the double latch. Follow the instructions printed on the metal sealing hatch or the illustrations shown below in this manual. The plastic cap will pop up automatically once the CPU is in place and the hatch properly sealed down.

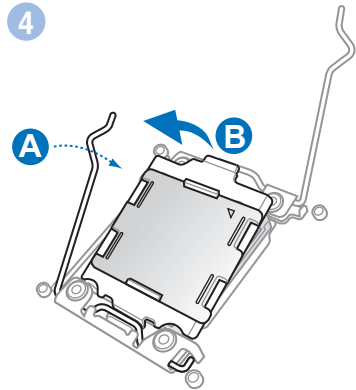
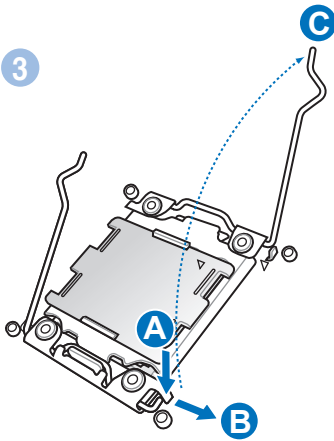
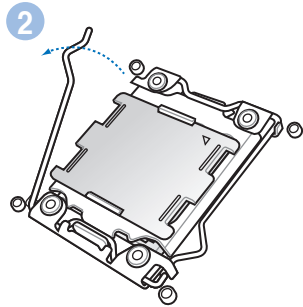
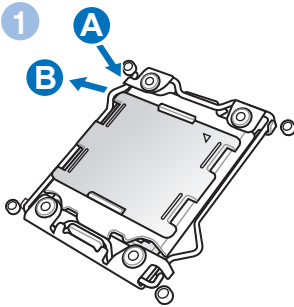

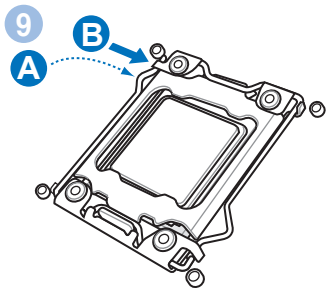
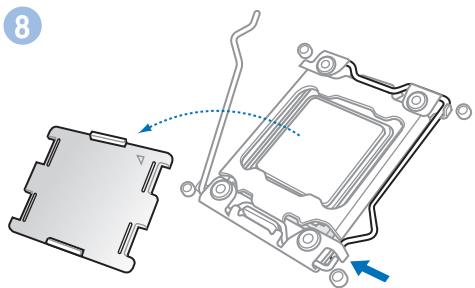
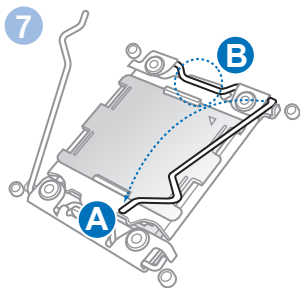
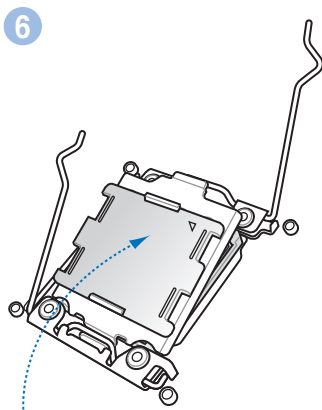
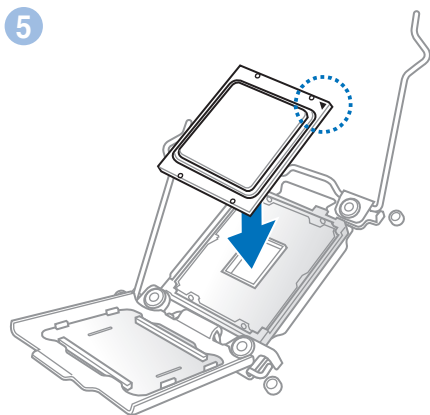

### 2.3.3 CPU heatsink and fan assembly installation

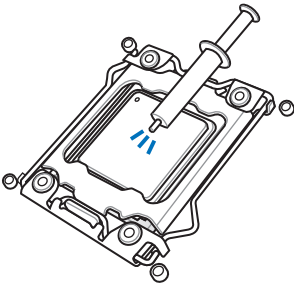

Apply the Thermal Interface Material to the CPU heatsink and CPU before you install the heatsink and fan if necessary.

To install the CPU heatsink and fan assembly

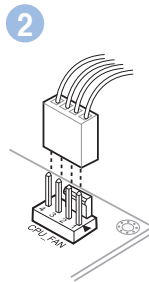
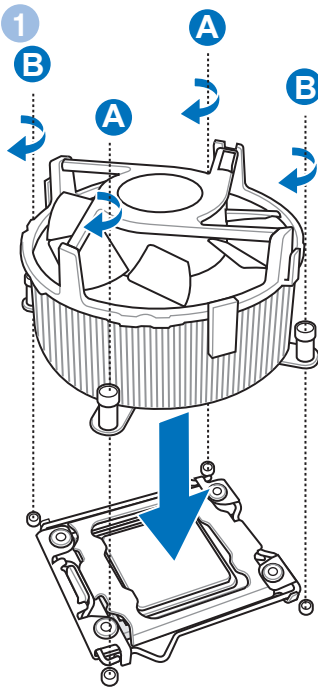

## To replace the LGA2011 CPU pad (X-Socket)

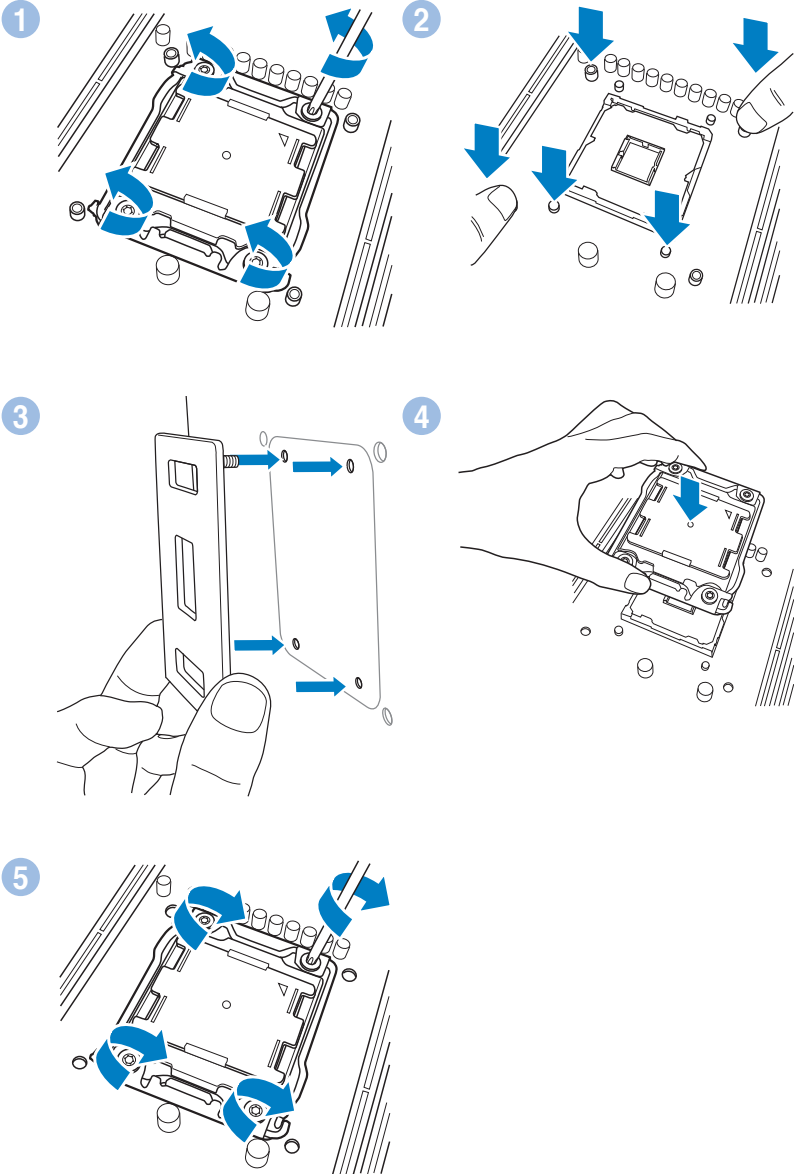

### 2.3.4 DIMM installation

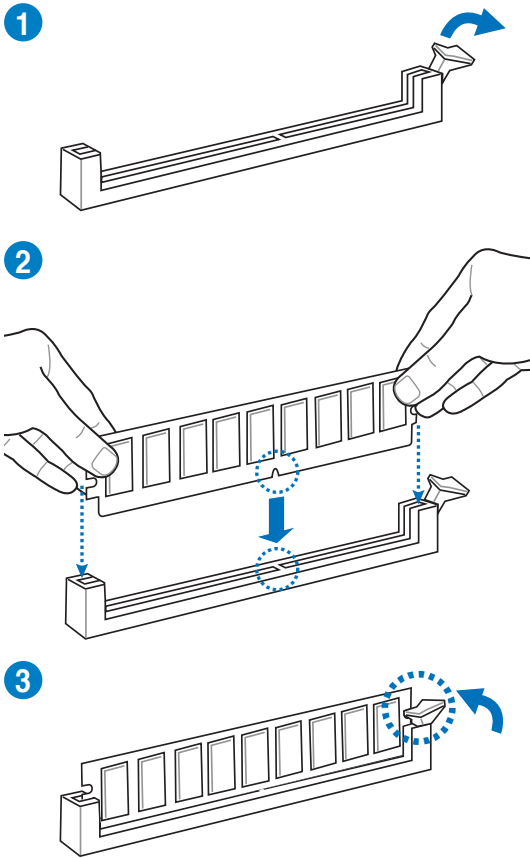

#### To remove a DIMM

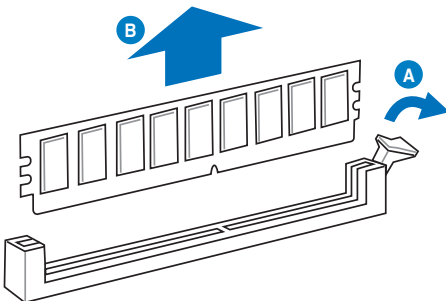

## 2.3.5 Motherboard installation



The diagrams in this section are for reference only. The motherboard layout may vary with models, but the installation steps remain the same.

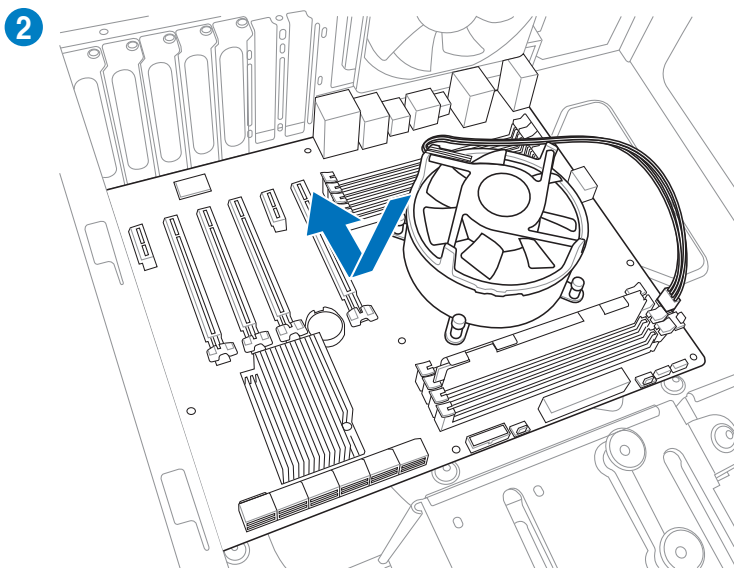
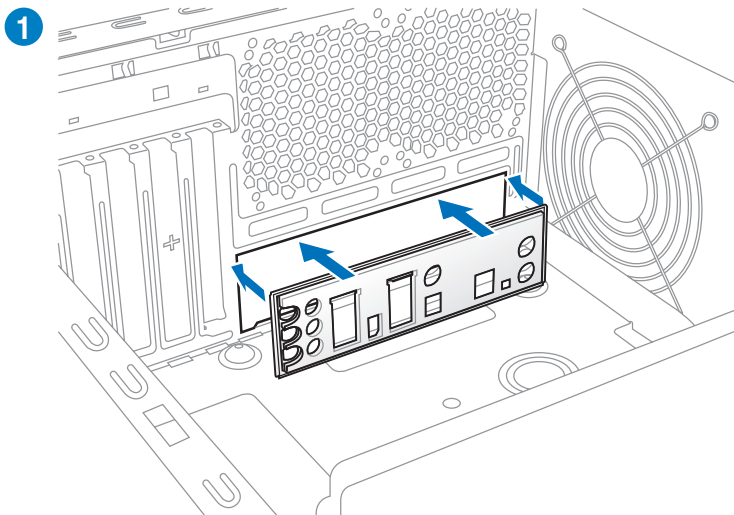



3

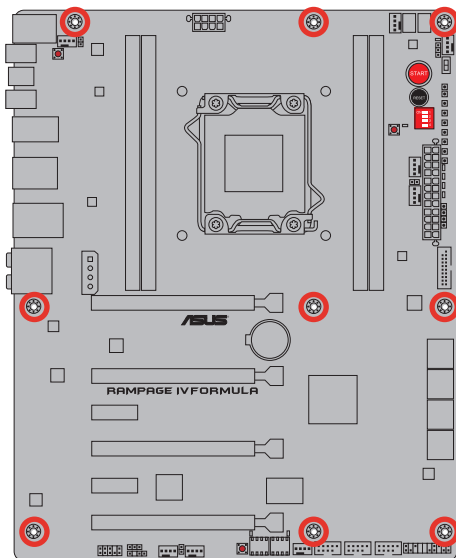
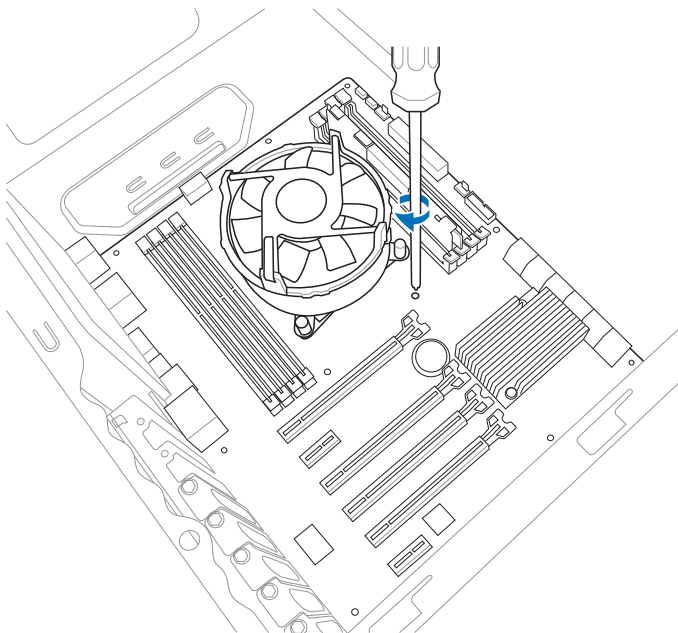

DO NOT overtighten the screws! Doing so can damage the motherboard.

### 2.3.6 ATX Power connection

1

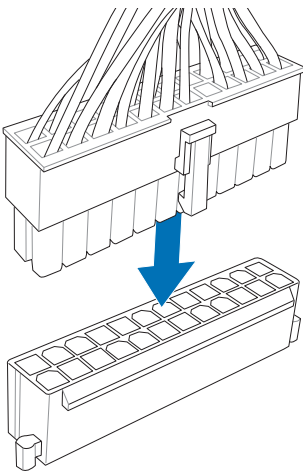

2

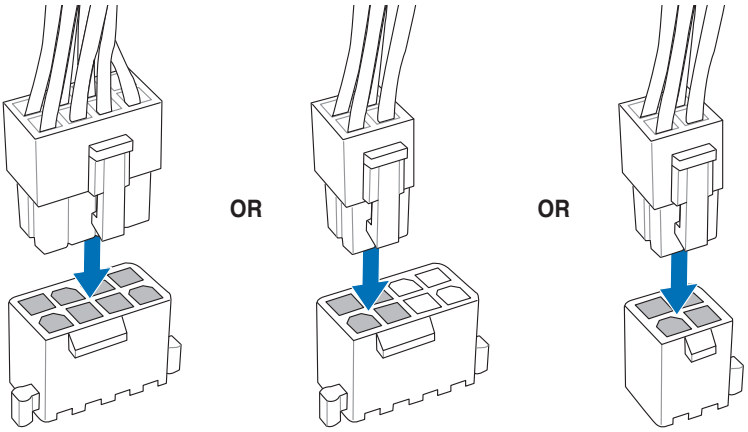

### 2.3.7 SATA device connection

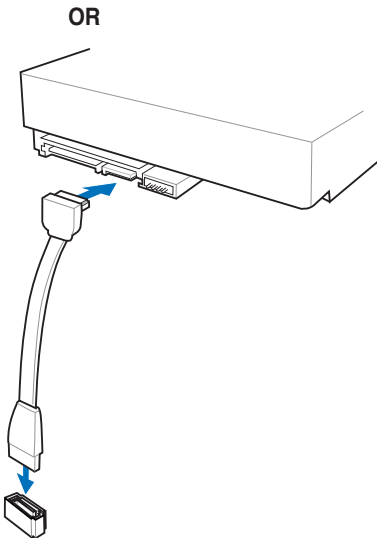
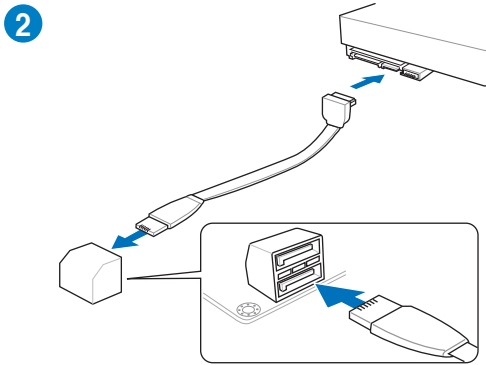
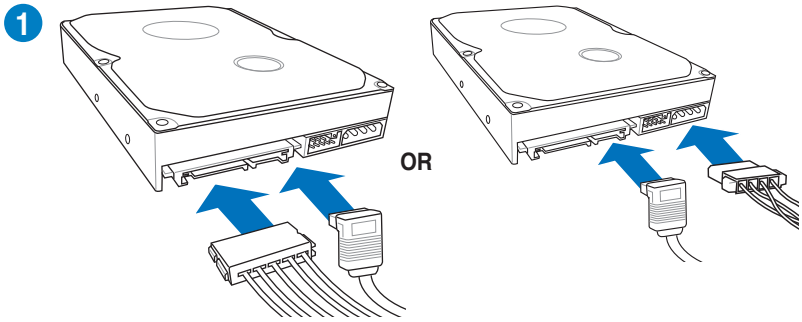

## 2.3.8 Front I/O Connector

### To install ASUS Q-Connector

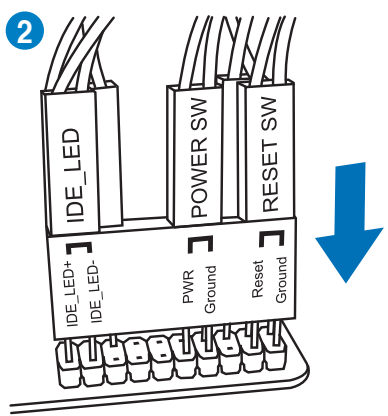
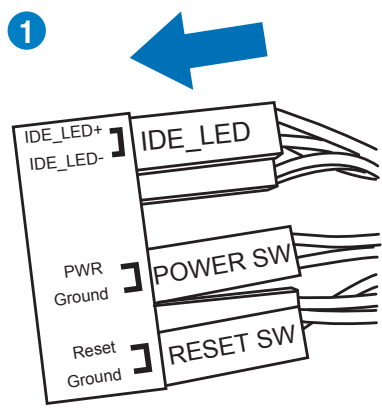

### To install USB 2.0 Connector

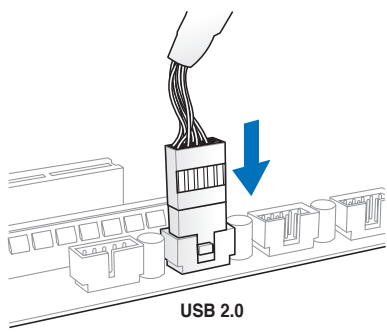

### To install front panel audio connector

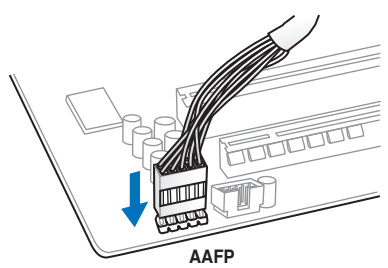

### To install USB 3.0 Connector

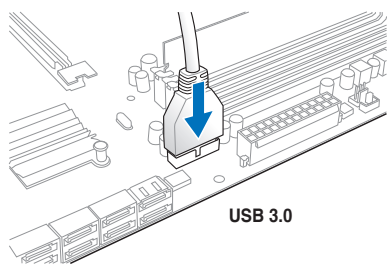

## 2.3.9 Expansion Card installation

To install PCIe x16 cards

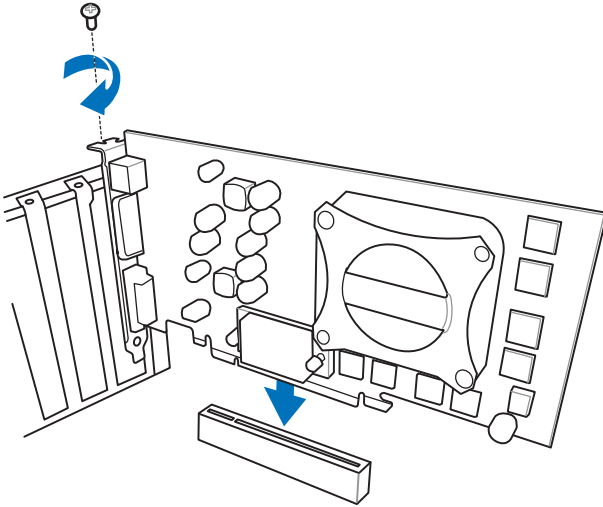

To install PCIe x1 cards

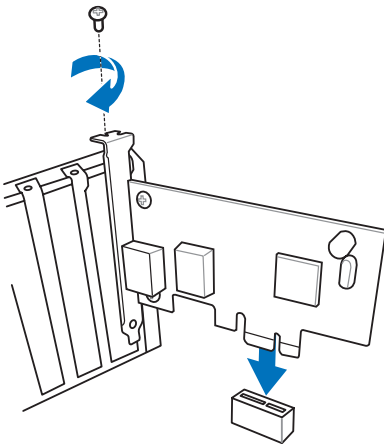

## 2.3.10 Rear panel connection

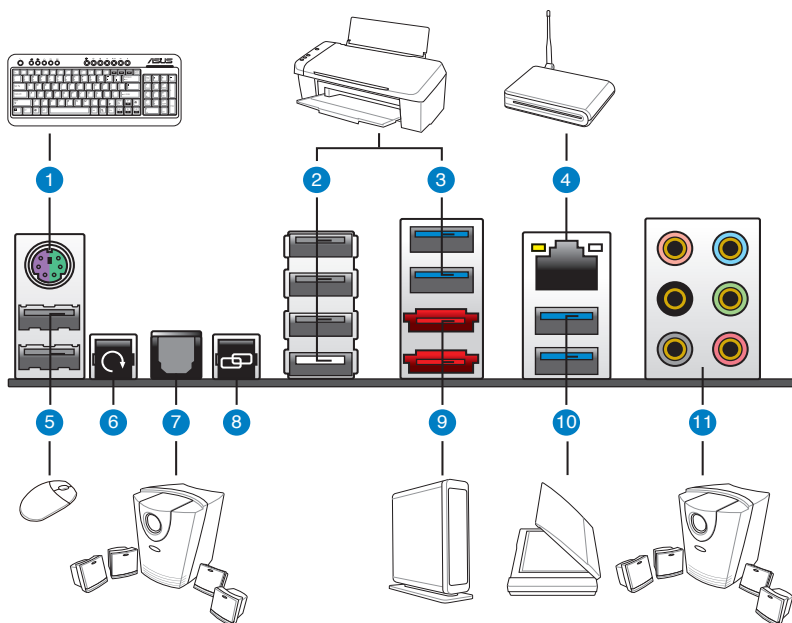

### Rear panel connectors

- |   |
|---|
| 1. PS/2 mouse and keyboard port                           |
| 2. USB 2.0 ports (the white port is also for ROG Connect) |
| 3. USB 3.0 ports  |
| 4. LAN (RJ-45) port*                                      |
| 5. USB 2.0 ports  |
| 6. Clear CMOS switch                                      |
| 7. Optical S/DIF out port                                 |
| 8. ROG Connect switch                                     |
| 9. External SATA ports                                    |
| 10. USB 3.0 ports   |
| 11. Audio I/O ports**                                     |

\* and \*\*: Refer to the tables on the next page for LAN port LED, and audio port definitions.



- Press the Clear CMOS switch to clear BIOS setup information only when the system hangs due to overclocking.
- DO NOT insert a different connector to the external SATA port.
- Due to USB 3.0 controller limitation, USB 3.0 devices can only be used under Windows® OS environment and after the USB 3.0 driver installation.
- USB 3.0 devices can only be used as data storage only.
- We strongly recommend that you connect USB 3.0 devices to USB 3.0 ports for faster and better performance for your USB 3.0 devices.
- If you want to use the hot-plug function of the external SATA ports, you have to set the **ASMedia® 1061 SATA controllers** item in the BIOS setting to [Enabled] and install the **ASMedia® 1061 SATA controllers** from the motherboard support DVD. Refer to section **3.5.5 Onboard Devices Configuration** for details.

### \* LAN ports LED indications

Activity Link LED		Speed LED	
Status	Description	Status	Description
OFF	No link	OFF	10 Mbps connection
ORANGE	Linked	ORANGE	100 Mbps connection
BLINKING	Data activity	GREEN	1 Gbps connection

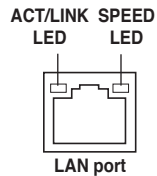

### \*\*Audio 2, 4, 6, or 8-channel configuration

Port	H e a d s e t 4-channel 2-channel		6-channel	8-channel
Light Blue	Line In	Line In	Line In	Line In
Lime	Line Out	Front Speaker Out	Front Speaker Out	Front Speaker Out
Pink	Mic In	Mic In	Mic In	Mic In
Orange	–	–	Center/Subwoofer	Center/Subwoofer
Black	–	Rear Speaker Out	Rear Speaker Out	Rear Speaker Out
Gray	–	–	–	Side Speaker Out

## 2.3.11 Audio I/O connections

### Audio I/O ports

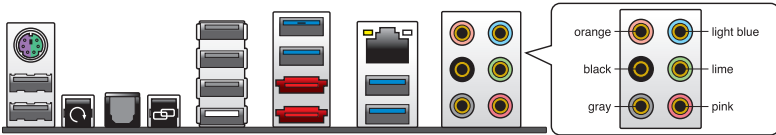

### Connect to Headphone and Mic

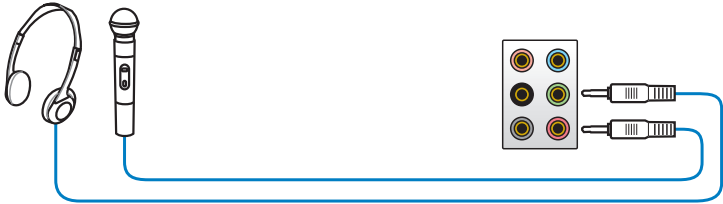

### Connect to Stereo Speakers

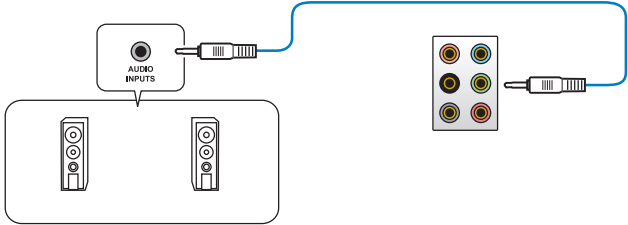

### Connect to 2.1 channel Speakers

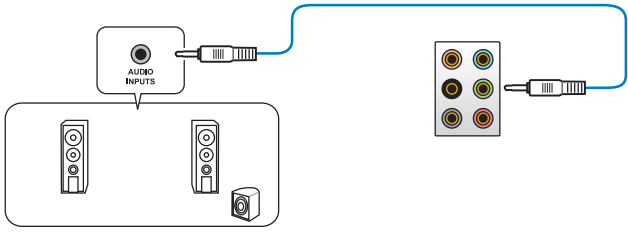



### Connect to 4.1 channel Speakers

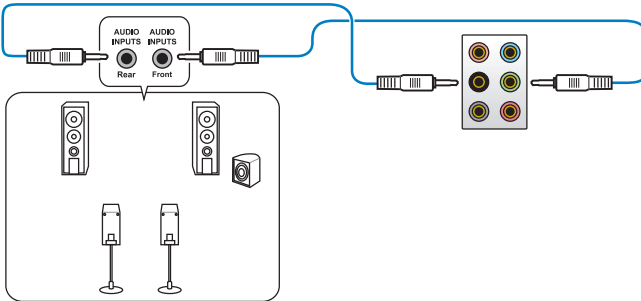

### Connect to 5.1 channel Speakers

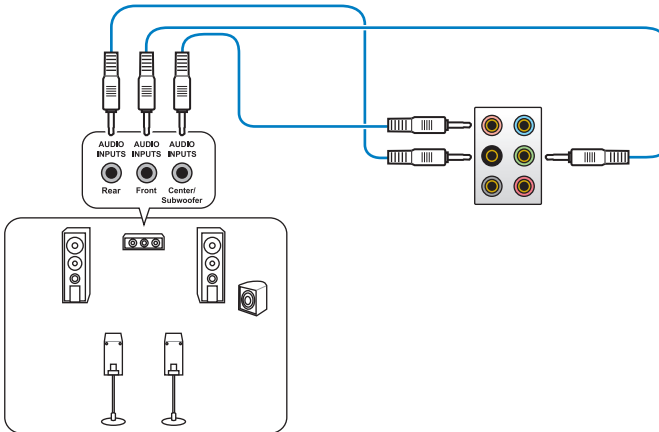

### Connect to 7.1 channel Speakers

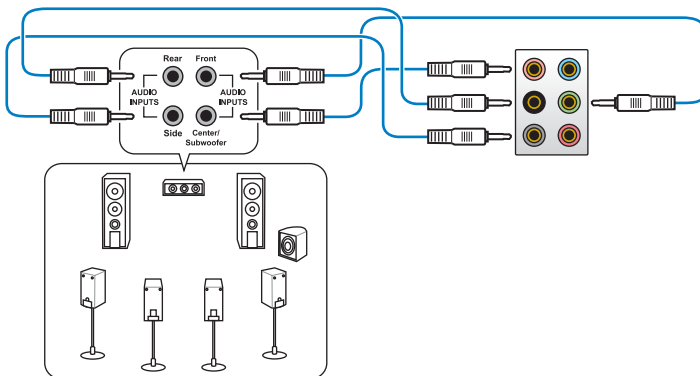

## 2.4 Starting up for the first time

1. After making all the connections, replace the system case cover.
2. Be sure that all switches are off.
3. Connect the power cord to the power connector at the back of the system chassis.
4. Connect the power cord to a power outlet that is equipped with a surge protector.
5. Turn on the devices in the following order:
  - a. Monitor
  - b. External SCSI devices (starting with the last device on the chain)
  - c. System power
6. After applying power, the system power LED on the system front panel case lights up. For systems with ATX power supplies, the system LED lights up when you press the ATX power button. If your monitor complies with the “green” standards or if it has a “power standby” feature, the monitor LED may light up or change from orange to green after the system LED turns on.

The system then runs the power-on self tests or POST. While the tests are running, the BIOS beeps (refer to the BIOS beep codes table below) or additional messages appear on the screen. If you do not see anything within 30 seconds from the time you turned on the power, the system may have failed a power-on test. Check the jumper settings and connections or call your retailer for assistance.

BIOS Beep	Description
One short beep	VGA detected Quick boot set to disabled No keyboard detected
One continuous beep followed by two short beeps then a pause (repeated)	No memory detected
One continuous beep followed by three short beeps	No VGA detected
One continuous beep followed by four short beeps	Hardware component failure

7. At power on, hold down the <Delete> key to enter the BIOS Setup. Follow the instructions in Chapter 3.

## 2.5 Turning off the computer

While the system is ON, pressing the power switch for less than four seconds puts the system on sleep mode or soft-off mode, depending on the BIOS setting. Pressing the power switch for more than four seconds lets the system enter the soft-off mode regardless of the BIOS setting.

# Chapter 3

## 3.1 Knowing BIOS



The new ASUS UEFI BIOS is a Unified Extensible Firmware Interface that complies with UEFI architecture, offering a user-friendly interface that goes beyond traditional keyboard-only BIOS controls to enable more flexible and convenient mouse input. Users can easily navigate the new UEFI BIOS with the same smoothness as their operating system. The term "BIOS" in this user manual refers to "UEFI BIOS" unless otherwise specified.

BIOS (Basic Input and Output System) stores system hardware settings such as storage device configuration, overclocking settings, advanced power management, and boot device configuration that are needed for system startup in the motherboard CMOS. In normal circumstances, the default BIOS settings apply to most conditions to ensure optimum performance. **We recommend that you not change the default BIOS settings** except in the following circumstances:

- An error message appears on the screen during the system bootup and requests you to run the BIOS Setup.
- You have installed a new system component that requires further BIOS settings or update.



Inappropriate settings of the BIOS may result in instability or failure to boot. **We strongly recommend that you change the BIOS settings only with the help of a trained service personnel.**

## 3.2 BIOS setup program

A BIOS setup program is provided for BIOS item modification. When you start up the computer, the system provides you with the opportunity to run this program. Press <Del> during the Power-On Self-Test (POST) to enter the Setup utility. Otherwise, POST continues with its test routines.

If you wish to enter Setup after POST, press <Ctrl> + <Alt> + <Delete>, or press the reset button on the system chassis to restart the system. You can also turn the system off and then turn it back on to restart the system. Do this last option only if the first two failed.



- The BIOS setup screens shown in this section are for reference purposes only, and may not exactly match what you see on your screen.
- Ensure that a USB mouse is connected to your motherboard if you want to use the mouse to control the BIOS setup program.
- If the system becomes unstable after changing any BIOS setting, load the default settings to ensure system compatibility and stability. Select the **Load Optimized Defaults** item under the **Exit** menu. See section 3.9 **Exit Menu** for details.
- If the system fails to boot after changing any BIOS setting, try to clear the CMOS and reset the motherboard to the default value. See section 2.3.10 **Rear Panel connection** for information on how to erase the RTC RAM.

The BIOS setup program is designed to make it as easy to use as possible. Being a menu-driven program, it lets you scroll through the various submenus and select from the available options using a keyboard or a USB mouse.

The BIOS setup program can be used under two modes: **EZ Mode** and **Advanced Mode**. You can change modes from the **Exit** menu or from the **Exit/Advanced Mode** button in the **EZ Mode/Advanced Mode** screen.

### 3.2.1 Advanced Mode

The Advanced Mode provides advanced options for experienced end-users to configure the BIOS settings. The figure below shows an example of the Advanced Mode. Refer to the following sections for the detailed configurations.



To access the EZ Mode, click **Exit**, then select **ASUS EZ Mode**.

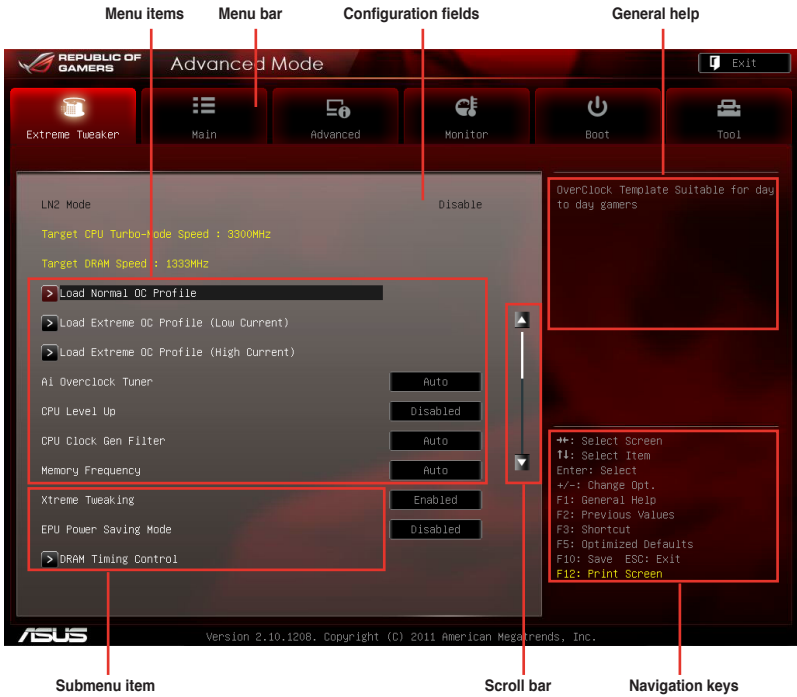

#### Menu bar

The menu bar on top of the screen has the following main items:

<b>Extreme Tweaker</b>	For changing the overclocking settings
<b>Main</b>	For changing the basic system configuration
<b>Advanced</b>	For changing the advanced system settings
<b>Monitor</b>	For displaying the system temperature, power status, and changing the fan settings.
<b>Boot</b>	For changing the system boot configuration
<b>Tool</b>	For configuring options for special functions
<b>Exit</b>	For selecting the exit options and loading default settings

## Menu items

The highlighted item on the menu bar displays the specific items for that menu. For example, selecting **Main** shows the Main menu items.

The other items (Extreme Tweaker, Advanced, Monitor, Boot, Tool, and Exit) on the menu bar have their respective menu items.

## Back button

This button appears when entering a submenu. Press <Esc> or use the USB mouse to click this button to return to the previous menu screen.

## Submenu items

A greater than sign (>) before each item on any menu screen means that the item has a submenu. To display the submenu, select the item and press <Enter>.

## Pop-up window

Select a menu item and press <Enter> to display a pop-up window with the configuration options for that item.

## Scroll bar

A scroll bar appears on the right side of a menu screen when there are items that do not fit on the screen. Press the Up/Down arrow keys or <Page Up> / <Page Down> keys to display the other items on the screen.

## Navigation keys

At the bottom right corner of the menu screen are the navigation keys for the BIOS setup program. Use the navigation keys to select items in the menu and change the settings.

## General help

At the top right corner of the menu screen is a brief description of the selected item.

## Configuration fields

These fields show the values for the menu items. If an item is user-configurable, you can change the value of the field opposite the item. You cannot select an item that is not user-configurable.

A configurable field is highlighted when selected. To change the value of a field, select it and press <Enter> to display a list of options.

### 3.2.2 EZ Mode

The EZ Mode provides you an overview of the basic system information, and allows you to select the display language, system performance mode and boot device priority. To access the Advanced Mode, click **Exit/Advanced Mode**, then select **Advanced Mode**.



The default screen for entering the BIOS setup program can be changed. Refer to the **Setup Mode** item in section 3.7 **Boot menu** for details.

Selects the display language of the BIOS setup program  
 Clicks to display all fan speeds if available  
 Displays the CPU/motherboard temperature, CPU/5V/3.3V/12V voltage output, CPU/Chassis/CPU\_OPT fan speed  
 Exits the BIOS setup program without saving the changes, saves the changes and resets the system, or enters the Advanced Mode  
 Selects the boot device priority  
 Power Saving mode  
 Normal mode  
 Loads optimized default  
 Displays the system properties of the selected mode on the right hand side  
 ASUS Optimal mode



- The boot device options vary depending on the devices you installed to the system.
- The **Boot Menu(F8)** button is available only when the boot device is installed to the system.

### 3.3 Extreme Tweaker menu

The Extreme Tweaker menu items allow you to configure overclocking-related items.



Be cautious when changing the settings of the Extreme Tweaker menu items. Incorrect field values can cause the system to malfunction.



The configuration options for this section vary depending on the CPU and DIMM model you installed on the motherboard.

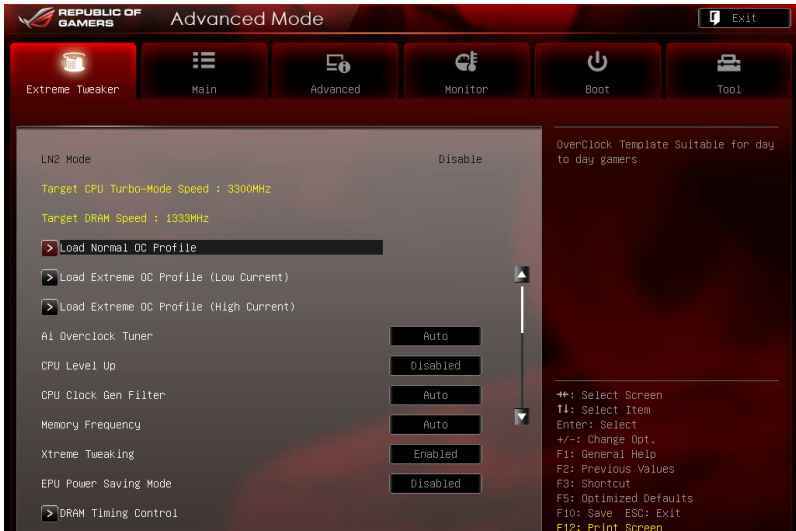

Scroll down to display the following items:



Scroll down to display the following items:

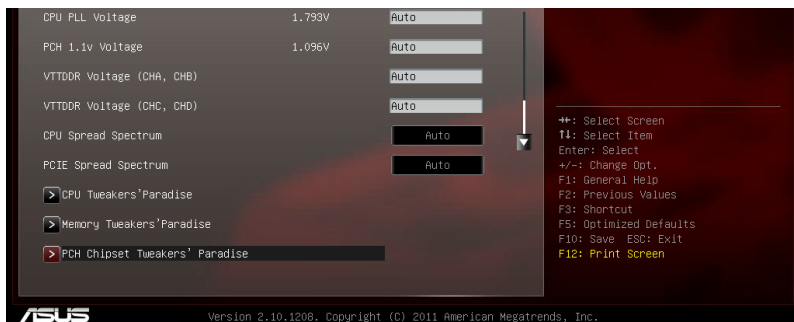

## Load Normal OC Profile

OverClock Template Suitable for day to day gamers.

## Load Extreme OC Profile (Low Current)

Sets sweet-spot settings for Extreme overclocking and sinks current away from the processor to preserve its life-span.

## Load Extreme OC Profile (High Current)

Sets sweet-spot settings for Extreme overclocking and sources current into the processor in a bid to squeeze more frequency from it.

## Ai Overclock Tuner [Auto]

Allows you to select the CPU overclocking options to achieve the desired CPU internal frequency. Select any of these preset overclocking configuration options:

- [Auto] Loads the optimal settings for the system.
- [Manual] Allows you to individually set overclocking parameters.
- [X.M.P.] The BCLK frequency, CPU ratio and memory parameters will be optimized.

## CPU Level Up [Disabled]

Allows you to select a CPU level, and the related parameters will be automatically adjusted according to the selected CPU level.

Configuration options: [Disabled] [X.XXXG]

### BCLK Frequency [XXX]

Allows you to adjust the CPU and VGA frequency to enhance the system performance. Use the <+> and <-> keys to adjust the value. You can also key in the desired value using the numeric keypad. The values range from 80.0MHz to 300.0MHz.

### CPU Strap [Auto]

Configuration options: [Auto] [100MHz] [125MHz] [166MHz] [250MHz]



### ClockGen Full Reset [Enabled]

[Enabled] Enabled for better overclocking.

[Disabled] To skip system shutdown at BCLK frequency adjustment.

---



The above three items appear only when you set the Ai Overclocking Tuner item to [Manual].

---

## **CPU CLOCK GEN Filter [Auto]**

Configuration options: [Auto] [Enabled] [Disabled] [10UF] [20UF]

## **Memory Frequency [Auto]**

Forces a DDR3 frequency slower than the common tCK detected via SPD.

Configuration options: [Auto] [DDR3-800MHz] [DDR3-1066MHz] [DDR3-1333MHz] [DDR3-1600MHz] [DDR3-1866MHz] [DDR3-2133MHz] [DDR3-2400MHz] [DDR3-2666MHz]

---



Selecting a very high memory frequency may cause the system to become unstable! If this happens, revert to the default setting.

---

## **Xtreme Tweaking [Disabled]**

This item may help improve some benchmarks performance.

Configuration options: [Disabled] [Enabled]

## **EPU Power Saving Mode [Disabled]**

Allows you to enable or disable the EPU power saving function.

Configuration options: [Disabled] [Enabled]

## **DRAM Timing Control**

The sub-items in this menu allow you to set the DRAM timing control features. Use the <+> and <-> keys to adjust the value. To restore the default setting, type [auto] using the keyboard and press the <Enter> key.

---



Changing the values in this menu may cause the system to become unstable! If this happens, revert to the default settings.

---

### Load Elipida Hyper Profile

Change settings to suit Elpida Hyper Profile by selecting Yes.

### Load Tight PSC Profile

Change settings to suit Tight PSC Profile by selecting Yes.

### Load Loose PSC Profile

Change settings to suit Loose PSC Profile by selecting Yes.

### Load RAW MHZ Profile

Change settings to suit RAW MHZ Profile by selecting Yes.

## **Rampage Tweak [Auto]**

Mode 1 can help Memory Compatibility. Mode 2 can help overclocking and performance. Configuration options: [Auto] [Mode 1] [Mode 2]

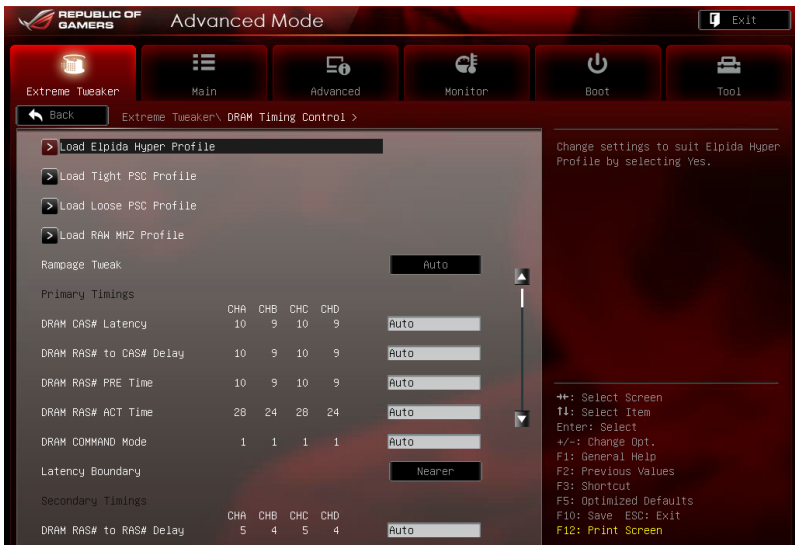

### Primary Timings

#### DRAM CAS# Latency [Auto]

Configuration options: [Auto] [3 DRAM Clock] – [15 DRAM Clock]

#### DRAM RAS# to CAS# Delay [Auto]

Configuration options: [Auto] [4 DRAM Clock] – [15 DRAM Clock]

#### DRAM RAS# PRE Time [Auto]

Configuration options: [Auto] [4 DRAM Clock] – [15 DRAM Clock]

#### DRAM RAS# ACT Time [Auto]

Configuration options: [Auto] [4 DRAM Clock] – [40 DRAM Clock]

#### DRAM COMMAND Mode [Auto]

Configuration options: [Auto] [1 DRAM Clock] [2 DRAM Clock] [3 DRAM Clock]

#### Latency Boudary [Nearer]

Configuration options: [Nearer] [Further]

### Secondary Timings

#### DRAM RAS# to RAS# Delay [Auto]

Configuration options: [Auto] [4 DRAM Clock] – [7 DRAM Clock]

#### DRAM REF Cycle Time [Auto]

Configuration options: [Auto] [48 DRAM Clock] – [511 DRAM Clock]

#### DRAM WRITE Recovery Time [Auto]

Configuration options: [Auto] [5 DRAM Clock] – [31 DRAM Clock]

DRAM READ to PRE Time [Auto]

Configuration options: [Auto] [4 DRAM Clock] – [15 DRAM Clock]

DRAM FOUR ACT WIN Time [Auto]

Configuration options: [Auto] [16 DRAM Clock] – [63 DRAM Clock]

DRAM WRITE to READ Delay [Auto]

Configuration options: [Auto] [4 DRAM Clock] – [15 DRAM Clock]

DRAM Write Latency [Auto]

Configuration options: [Auto] [1 DRAM Clock] – [15 DRAM Clock]

**Third Timings**tRRDR [Auto]

Configuration options: [Auto] [0 DRAM Clock] – [7 DRAM Clock]

tRRDD [Auto]

Configuration options: [Auto] [0 DRAM Clock] – [7 DRAM Clock]

tWWDR [Auto]

Configuration options: [Auto] [0 DRAM Clock] – [7 DRAM Clock]

tWWDD [Auto]

Configuration options: [Auto] [0 DRAM Clock] – [7 DRAM Clock]

tRWDR [Auto]

Configuration options: [Auto] [0 DRAM Clock] – [15 DRAM Clock]

tRWDD [Auto]

Configuration options: [Auto] [0 DRAM Clock] – [15 DRAM Clock]

tWRDR [Auto]

Configuration options: [Auto] [0 DRAM Clock] – [7 DRAM Clock]

tWRDD [Auto]

Configuration options: [Auto] [0 DRAM Clock] – [7 DRAM Clock]

tRWSR [Auto]

Configuration options: [Auto] [0 DRAM Clock] – [15 DRAM Clock]

tCCD [Auto]

Configuration options: [Auto] [0 DRAM Clock] – [7 DRAM Clock]

**Latency Timings**DRAM RTL (CHA/B/C/D D0/1 R0/1 [Auto])

Configuration options: [Auto] [Advance 14 Clock] [Advance 12 Clock] – [Advance 4 Clock] [Advance 2 Clock] [Normal] [Delay 2 Clock] [Delay 4 Clock] – [Delay 12 Clock] [Delay 14 Clock]

DRAM IOL (CHA/B/C/D D0/1 R0/1 [Auto])

Configuration options: [Auto] [Advance 14 Clock] – [Advance 1 Clock] [Normal] [Delay 1 Clock] – [Delay 14 Clock]

## others

### *DRAM CLK Period*

Configuration options: [Auto] [1 DRAM Clock] – [7 DRAM Clock]

## DIGI+ Power Control



Do not remove the thermal module while changing the DIGI+ Power Control related parameters. The thermal conditions should be monitored.

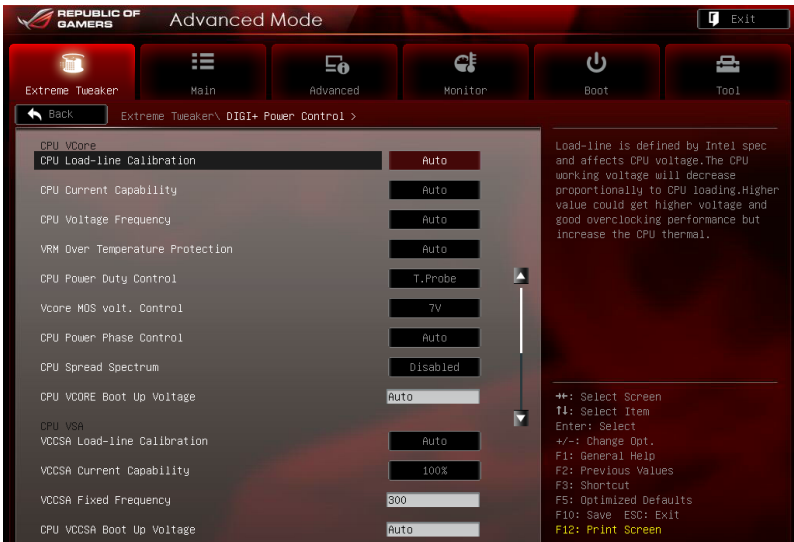

Some of the following items are adjusted by typing the desired values using the numeric keypad and press the <Enter> key. You can also use the <+> and <-> keys to adjust the value. To restore the default setting, type [auto] using the keyboard and press the <Enter> key.

### *CPU Load-Line Calibration [Auto]*

CPU Load-line is defined by Intel VRM spec and affects CPU voltage. The CPU working voltage will decrease proportionally to CPU loading. Higher load-line calibration would get higher voltage and better overclocking performance, but increase the CPU and VRM thermal. This item allows you to adjust the voltage range from the following percentages to boost the system performance: 0% (Regular), 25% (Medium), 50% (High), 75% (Ultra High) and 100% (Extreme).

Configuration options: [Auto] [Regular] [Medium] [High] [Ultra High] [Extreme]



---

The actual performance boost may vary depending on your CPU specification.

---

#### CPU Current Capability [Auto]

This item provides wider total power range for overclocking. A higher value brings a wider total power range and extends the overclocking frequency range simultaneously. Configuration options: [Auto] [100%] [110%] [120%] [130%] [140%] [150%] [160%] [170%] [180%] [Disabled]

#### CPU Voltage Frequency [Auto]

Switching frequency will affect the transient response and component thermal. Higher frequency gets quicker transient response. Configuration options: [Auto] [Manual]

#### VRM Over Temperature Protection [Auto]

This item allows you to enable or disable the VRM over temperature protection. Configuration options: [Auto] [Disabled]

#### CPU Power Duty Control [T.Probe]

[T.Probe] Maintains the VRM thermal balance.  
[Extreme] Maintains the VRM current balance.

#### Vcore MOS volt. Control [Auto]

Configuration options: [Auto] [6V] [6.5V] [7V] [7.5V] [8V] [8.5V] [9V] [9.5V] [10V]

#### CPU Power Phase Control [Auto]

Phase number is the number of working VRM phase. Increasing phase number under heavy system loading to get more transient and better thermal performance. Reducing phase number under light system loading to increase VRM efficiency

[Standard] Proceeds phase control depending on the CPU loading.  
[Optimized] Loads the ASUS optimized phase tuning profile.  
[Extreme] Proceeds the full phase mode.  
[Manual Adjustment] Allows manual adjustment.

#### CPU Spread Spectrum [Disabled]

Configuration options: [Disabled] [Enabled]

#### CPU VCore Bootup Voltage [Auto]

This item controls the voltage for CPU at initial boot. Set higher value for better overclockability. The values range from 0.800V to 1.990V with a 0.005V interval.

### **CPU VSA**

#### VCCSA Load-line calibration [Auto]

The behavior of the DRAM controller is decided by VCCSA Load-Line. Set to a higher value for system performance, or to a lower value for better thermal solution. Configuration options: [Auto] [Regular] [High] [Extreme]

#### VCCSA Current Capability [100%]

Allows you to set the VCCSA current capability. A higher value brings wider total DRAM controller power range and extends the overclocking frequency range simultaneously. Configuration options: [100%] [110%] [120%] [130%] [140%]

VCCSA Fixed Frequency [XXX]

The values range from 300kHz to 600kHz with a 50kHz interval.

CPU VCCSA Boot up Voltage [Auto]

This item controls the voltage for CPU VCCSA at initial boot. Set higher value for better overclockability. The values range from 0.800V to 1.700V with a 0.005V interval.

**CPU VTT**CPU VTT Switching Freq [Auto]

This item allows you to switch the frequency of VTT power. Set 1.3x for cleaner power. Configuration options: [Auto] [1x] [1.3x]

CPU VTT Over-Current Protection [Auto]

This item allows you to enable or disable the CPU VTT over-current protection. Set to [Disabled] to remove over-current protection on VTT power. Configuration options: [Auto] [Enabled] [Disabled]

**DRAM Voltage**DRAM-AB/DRAM-CD Current Capability [100%]

Setting a higher value brings a wider total power range and extends the overlocking frequency range simultaneously.

Configuration options: [100%] [110%] [120%] [130%] [140%]

DRAM-AB/DRAM-CD Voltage Frequency [Auto]

This item allows you to adjust the DRAM switching frequency. Assign a fixed high DRAM frequency to increase O.C range or a lower DRAM frequency for better system stability. Configuration options: [Auto] [manual]

DRAM-AB/DRAM-CD Power Phase control [Auto]

[Optimized] Allows you to set ASUS optimized phase tuning profile.

[Extreme] Allows you to set the Full phase mode.

**PCH 1.1V**PCH 1.1v Switching Freq. [Auto]

This item allows you to switch the frequency of PCH power. Set 1.3x for cleaner power. Configuration options: [Auto] [1x] [1.3x]

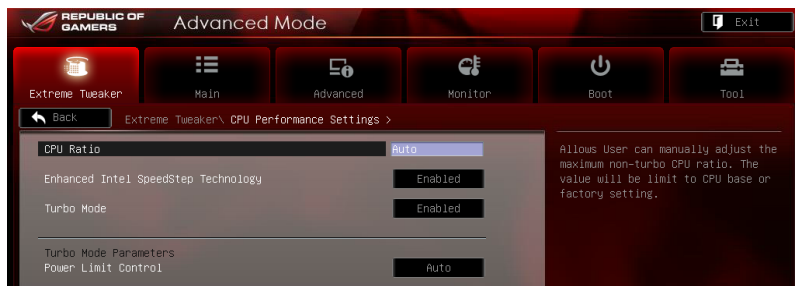
**CPU Performance Settings**

### CPU Ratio [Auto]

Allows you to manually adjust the maximum non-turbo CPU ratio. Use <+> and <-> keys to adjust the value. The valid value ranges vary according to your CPU model.

### Enhanced Intel SpeedStep Technology [Enabled]

Allows you to enable or disable the Enhanced Intel® SpeedStep Technology.

[Disabled] Disables this function.

[Enabled] The operating system dynamically adjusts the processor voltage and core frequency which may result in decreased average consumption and decreased average heat production.

### Turbo Mode [Enabled]

[Disabled] Disables this function.

[Enabled] Allows processor cores to run faster than marked frequency in specific condition.

### Power Limit Control [Auto]

This item appears only when you set the **CPU Ratio** item to [Auto] and the **Turbo Mode** item to [Enabled]. Leave this item at [Auto] for best overclocking or set to [Enabled] to customize settings. Configuration options: [Auto] [Enabled]



The following items appear only when you set the **Turbo Mode** items to [Enabled] and **Power Limit Control** item to [Enabled].

### Long Duration Power Limit [Auto]

Use the <+> and <-> keys to adjust the value.

### Long Duration Maintained [Auto]

Use the <+> and <-> keys to adjust the value.

### Short Duration Power Limit [Auto]

Use the <+> and <-> keys to adjust the value.

### CPU Core Current Limit [Auto]

Use the <+> and <-> keys to adjust the value.

## GPU/DIMM Post

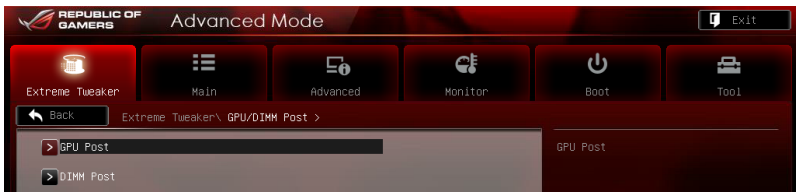

### GPU Post

The **GPU Post** sub-menu allows you to view the information of individual PCI Express slots.

PCIe Lane Simulator

The **PCIe Lane Simulator** item allows you to simulate PCIe lane arrangement.

### DIMM Post

The **DIMM Post** sub-menu allows you to view the information of installed DIMMs.

## **Extreme OV [Disable]**

This item is set to [Disabled] by default to protect the CPU from being overheated. Set this item to [Enabled] to choose a higher voltage to overclock, but doing so might decrease CPU life. Configuration options: [Disabled] [Enabled]

## **BCLK Skew [Auto]**

Reduce the value to improve BCLK margin.

Configuration options: [Auto] [-5] – [+3]

## **CPU VCORE Voltage [Manual Mode]**

[Manual Mode] Allows you to set a fixed CPU voltage.

[Offset Mode] Allows you to set the Offset voltage.

### CPU VCORE Manual Voltage [Auto]

This item appears only when you set the **CPU VCORE Voltage** item to [Manual Mode] and allows you to set a fixed CPU voltage. The values range from 0.800V to 2.100V with a 0.005V interval.

## **Offset Mode Sign [+]**

This item appears only when you set the **CPU VCORE Voltage** item to [Offset Mode].

[+] To offset the voltage by a positive value.

[-] To offset the voltage by a negative value.

### CPU VCORE Offset Voltage [Auto]

This item allows you to set the Offset voltage. The values range from 0.005V to 0.635V with a 0.005V interval.

## **VTT CPU Voltage [Auto]**

Allows you to set the VTT CPU voltage. The values range from 0.8000V to 1.7000V with a 0.00625V interval.



Refer to the CPU documentation before setting the CPU voltage. Setting a high voltage may damage the CPU permanently, and setting a low voltage may make the system unstable.

## **2nd VTTCPU Voltage [Auto]**

Allows you to set the second VTTCPU voltage. The values range from 0.80642V to 1.70538V with a 0.00661V interval.



**CPU VCCSA Voltage [Manual Mode]**

[Manual Mode] Allows you to set a fixed CPU voltage.

[Offset Mode] Allows you to set the Offset voltage.

***CPU VCCSA Manual Voltage [Auto]***

This item appears only when you set the **CPU VCCSA Voltage** item to [Manual Mode] and allows you to set a fixed CPU voltage. The values range from 0.800V to 2.100V with a 0.005V interval.

**Offset Mode Sign [+]**

This item appears only when you set the **CPU VCCSA Voltage** item to [Offset Mode].

[+] To offset the voltage by a positive value.

[-] To offset the voltage by a negative value.

***CPU VCCSA Offset Voltage [Auto]***

This item allows you to set the Offset voltage. The values range from 0.005V to 0.635V with a 0.005V interval.

**DRAM Voltage (CHA, CHB) [Auto]**

Allows you to set the DRAM voltage for DRAM channel A and B. The values range from 1.20V to 2.10V with a 0.005V interval.

**DRAM Voltage (CHC, CHD) [Auto]**

Allows you to set the DRAM voltage for DRAM channel C and D. The values range from 1.20V to 2.10V with a 0.005V interval.



According to Intel CPU spec, DIMMs with voltage requirement over 1.65V may damage the CPU permanently. We recommend you install the DIMMs with the voltage requirement below 1.65V.

**CPU PLL Voltage [Auto]**

Allows you to set the CPU PLL voltage. The values range from 1.2500V to 2.5000V with a 0.00625V interval.

**PCH 1.1v Voltage [Auto]**

Allows you to set the 1.1v Platform Controller Hub voltage. The values range from 0.8000V to 1.6000V with a 0.00625V interval.

**VTTDDR Voltage (CHA, CHB) [Auto]**

Allows you to set the VTTDDR voltage for DRAM channel A and B. The values range from 0.6250V to 1.1000V with a 0.00625V interval.

**VTTDDR Voltage (CHC, CHD) [Auto]**

Allows you to set the VTTDDR voltage for DRAM channel C and D. The values range from 0.6250V to 1.1000V with a 0.00625V interval.

### CPU Spread Spectrum [Disabled]

- [Auto] Loads the optimized setting for the system.
- [Disabled] Enhances the BCLK overclocking ability.
- [Enabled] Sets to [Enabled] for EMI control.

### PCIe Spread Spectrum [Disabled]

- [Auto] Loads the optimized setting for the system.
- [Disabled] Enhances the PCIe overclocking ability.
- [Enabled] Sets to [Enabled] for EMI control.

### CPU Tweakers' Paradise

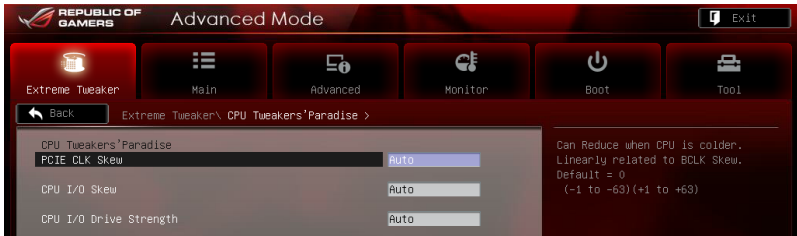

#### PCIE CLK Skew [Auto]

Configuration options: [-63] – [-1] [Auto] [+1] – [+63]

#### CPU I/O Skew [Auto]

Configuration options: [-63] – [-1] [Auto] [+1] – [+63]

#### CPU I/O Drive Strength [Auto]

Configuration options: [-63] – [-1] [Auto] [+1] – [+63]

### Memory Tweakers' Paradise

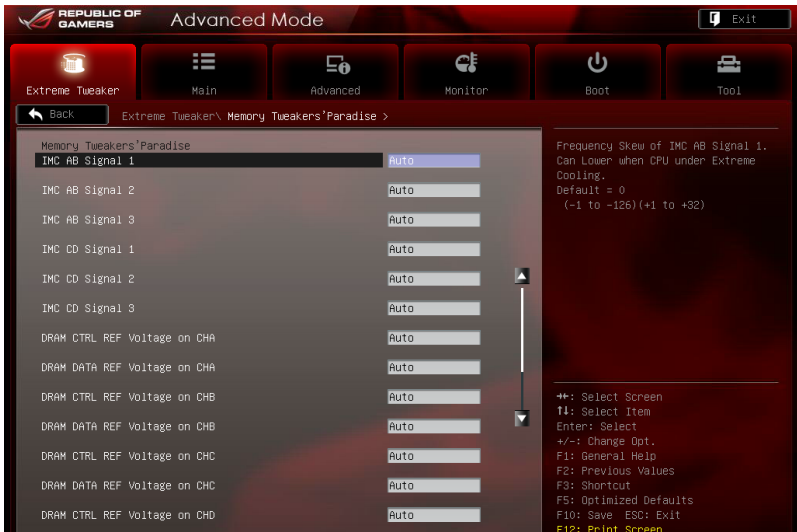

IMC AB/CD Signal 1/2/3 [Auto]

Configuration options: [-126] – [-1] [Auto] [+1] – [+32]

DRAM CTRL REF Voltage on CHA/B/C/D

The values range from 0.3950x to 0.6300x with a 0.0050x interval.

DRAM DATA REF Voltage on CHA/B/C/D

The values range from 0.3950x to 0.6300x with a 0.0050x interval.

DRAM Read REF Voltage on CHA/B/C/D

The values range from 0.38500x to 0.61500x with a 0.0050x interval.

## PCH Chipset Tweakers' Paradise

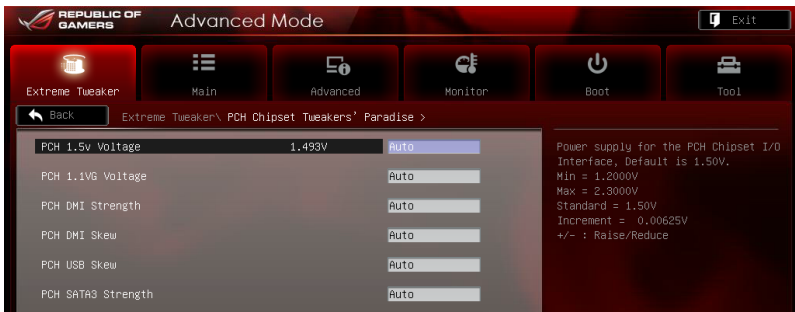

PCH 1.5v Voltage [Auto]

The values range from 1.2000V to 2.3000V with a 0.00625V interval.

PCH 1.1vG Voltage [Auto]

The values range from 0.80642V to 1.60623V with a 0.00661V interval.

PCH DMI Strength [Auto]

Configuration options: [-96] – [-1] [Auto] [+1] – [+96]

PCH DMI Skew [Auto]

Configuration options: [-96] – [-1] [Auto] [+1] – [+96]

PCH USB Skew [Auto]

Configuration options: [-96] – [-1] [Auto] [+1] – [+96]

PCH SATA3 Strength [Auto]

Configuration options: [-96] – [-1] [Auto] [+1] – [+96]

## 3.4 Main menu

The Main menu provides you an overview of the basic system information, and allows you to set the system date, time, language, and security settings.



### 3.4.1 System Language [English]

Allows you to choose the BIOS language version from the options.

### 3.4.2 System Date [Day xx/xx/xxxx]

Allows you to set the system date.

### 3.4.3 System Time [xx:xx:xx]

Allows you to set the system time.

### 3.4.4 Security

The Security menu items allow you to change the system security settings.

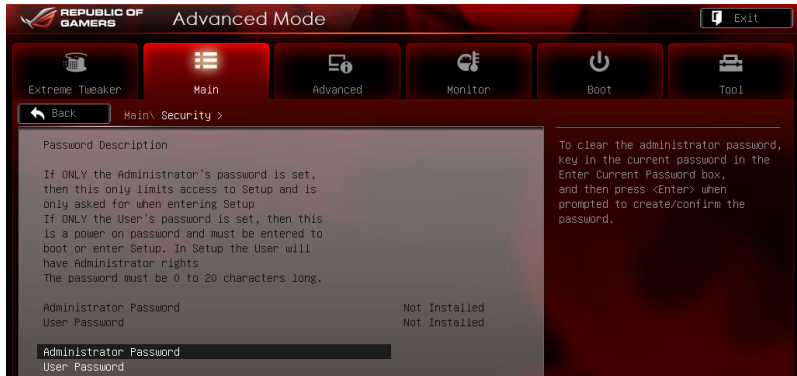

- If you have forgotten your BIOS password, erase the CMOS Real Time Clock (RTC) RAM to clear the BIOS password. See section 2.3.10 Rear panel connection for information on how to erase the RTC RAM.
- The **Administrator** or **User Password** items on top of the screen show the default **Not Installed**. After you set a password, these items show **Installed**.

#### Administrator Password

If you have set an administrator password, we recommend that you enter the administrator password for accessing the system. Otherwise, you might be able to see or change only selected fields in the BIOS setup program.

To set an administrator password:

1. Select the **Administrator Password** item and press <Enter>.
2. From the **Create New Password** box, key in a password, then press <Enter>.
3. Confirm the password when prompted.

To change an administrator password:

1. Select the **Administrator Password** item and press <Enter>.
2. From the **Enter Current Password** box, key in the current password, then press <Enter>.
3. From the **Create New Password** box, key in a new password, then press <Enter>.
4. Confirm the password when prompted.

To clear the administrator password, follow the same steps as in changing an administrator password, but press <Enter> when prompted to create/confirm the password. After you clear the password, the **Administrator Password** item on top of the screen shows **Not Installed**.

## User Password

If you have set a user password, you must enter the user password for accessing the system. The **User Password** item on top of the screen shows the default **Not Installed**. After you set a password, this item shows **Installed**.

To set a user password:

1. Select the **User Password** item and press <Enter>.
2. From the **Create New Password** box, key in a password, then press <Enter>.
3. Confirm the password when prompted.

To change a user password:

1. Select the **User Password** item and press <Enter>.
2. From the **Enter Current Password** box, key in the current password, then press <Enter>.
3. From the **Create New Password** box, key in a new password, then press <Enter>.
4. Confirm the password when prompted.

To clear the user password, follow the same steps as in changing a user password, but press <Enter> when prompted to create/confirm the password. After you clear the password, the **User Password** item on top of the screen shows **Not Installed**.

## 3.5 Advanced menu

The Advanced menu items allow you to change the settings for the CPU and other system devices.



Be cautious when changing the settings of the Advanced menu items. Incorrect field values can cause the system to malfunction.

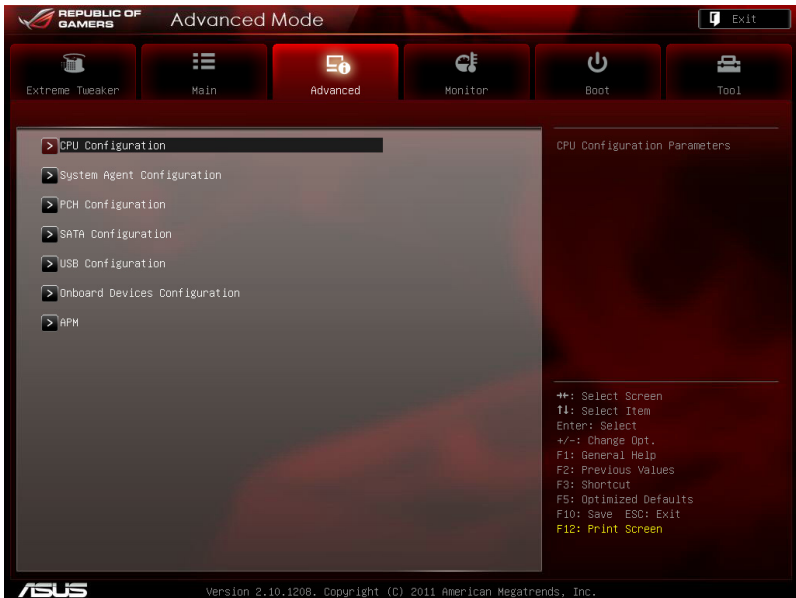

### 3.5.1 CPU Configuration

The items in this menu show the CPU-related information that the BIOS automatically detects.



The items shown in this screen may be different due to the CPU you installed.



Scroll down to display the following items:

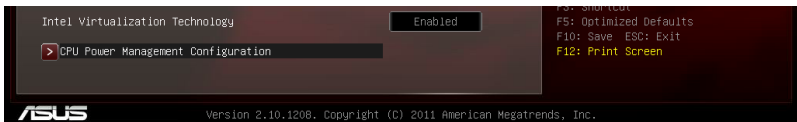

#### Intel Adaptive Thermal Monitor [Enabled]

[Disabled] Disables the CPU thermal monitor function.

[Enabled] Enables the overheated CPU to throttle its clock speed to cool down.

#### Hyper-threading [Enabled]

The Intel Hyper-Threading Technology allows each hyper-threading processor core to appear as two virtual cores to the operating system, enabling the operating system to schedule two threads or processes simultaneously.

[Disabled] Only one thread per activated core is enabled.

[Enabled] Two threads per activated core are enabled.

#### Active Processor Cores [All]

Allows you to choose the number of CPU cores to activate in each processor package. Configuration options: [All] [1] [2] [3] [4] [5]



**Limit CPUID Maximum [Disabled]**

- [Enabled] Allows legacy operating systems to boot even without support for CPUs with extended CPUID functions.
- [Disabled] Disables this function.

**Execute Disable Bit [Enabled]**

- [Enabled] Enables the No-Execution Page Protection Technology.
- [Disabled] Forces the XD feature flag to always return to zero (0).

**Intel Virtualization Technology [Enabled]**

- [Enabled] Allows a hardware platform to run multiple operating systems separately and simultaneously, enabling one system to virtually function as several systems.
- [Disabled] Disables this function.

**CPU Power Management Configuration**CPU Ratio [Auto]

Allows you to set the ratio between the CPU Core Clock and the BCLK Frequency. Use <-> and <-> keys to adjust the ratio. The valid value ranges vary according to your CPU model.

Enhanced Intel SpeedStep Technology [Enabled]

Allows you to enable or disable the Enhanced Intel® SpeedStep Technology (EIST).

- [Disabled] The CPU runs at its default speed.
- [Enabled] The operating system controls the CPU speed.

Turbo Mode [Enabled]

- [Disabled] Disables this function.
- [Enabled] Allows processor cores to run faster than marked frequency in specific condition.

CPU C1E [Auto]

- [Disabled] Disables this function.
- [Enabled] Enables the C1E support function. This item should be enabled in order to enable the Enhanced Halt State.

CPU C3 Report [Auto]

Allows you to disable or enable the CPU C3 report to OS.

CPU C6 Report [Auto]

Allows you to disable or enable the CPU C6 report to OS.

CPU C7 Report [Auto]

Allows you to disable or enable the CPU C7 report to OS.

### 3.5.2 System Agent Configuration



#### PCIE\_X16\_1 Link Speed [GEN3]

Select Target Link Speed Gen1, Gen2 or Gen3.  
Configuration options: [GEN1] [GEN2] [GEN3]

#### PCIE\_X16/X8\_3 and PCIe\_X8\_4 Link Speed [GEN3]

Select Target Link Speed Gen1, Gen2 or Gen3.  
Configuration options: [GEN1] [GEN2] [GEN3]

#### PCIE\_X8\_2 Link Speed [GEN3]

Select Target Link Speed Gen1, Gen2 or Gen3.  
Configuration options: [GEN1] [GEN2] [GEN3]

### 3.5.3 PCH Configuration

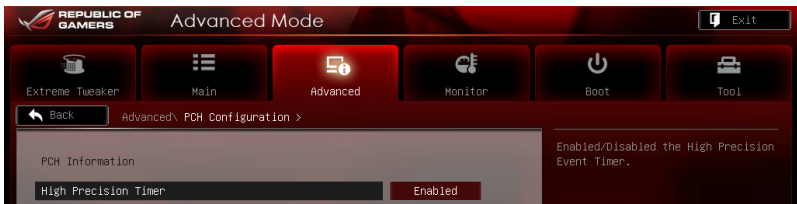

#### High Precision Timer [Enabled]

Allows you to enable or disable the High Precision Event Timer.  
Configuration options: [Disabled] [Enabled]

## 3.5.4 SATA Configuration

While entering Setup, the BIOS automatically detects the presence of SATA devices. The SATA Port items show **Not Present** if no SATA device is installed to the corresponding SATA port.

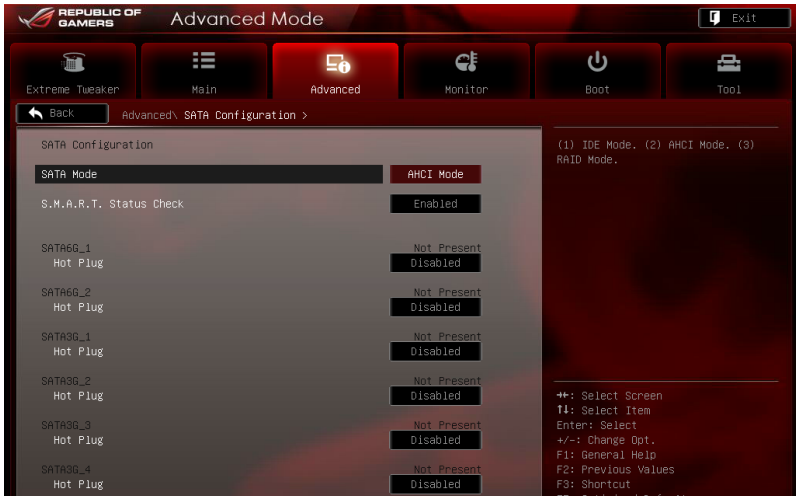

### SATA Mode [AHCI Mode]

Allows you to set the SATA configuration.

- [Disabled] Disables the SATA function.
- [IDE Mode] Set to [IDE Mode] when you want to use the Serial ATA hard disk drives as Parallel ATA physical storage devices.
- [AHCI Mode] Set to [AHCI Mode] when you want the SATA hard disk drives to use the AHCI (Advanced Host Controller Interface). The AHCI allows the onboard storage driver to enable advanced Serial ATA features that increases storage performance on random workloads by allowing the drive to internally optimize the order of commands.
- [RAID Mode] Set to [RAID Mode] when you want to create a RAID configuration from the SATA hard disk drives.

### S.M.A.R.T. Status Check [Enabled]

S.M.A.R.T. (Self-Monitoring, Analysis and Reporting Technology) is a monitor system. When read/write of your hard disk errors occur, this feature allows the hard disk to report warning messages during the POST. Configuration options: [Enabled] [Disabled]

### Hot Plug [Disabled]

These items appear only when you set the **SATA Mode** item to [AHCI Mode] or [RAID Mode] and allow you to enable/disable SATA Hot Plug Support. Configuration options: [Disabled] [Enabled].

### 3.5.5 USB Configuration

The items in this menu allow you to change the USB-related features.

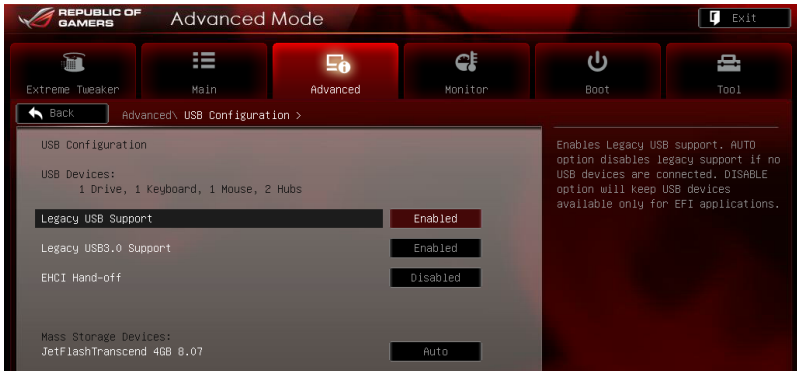

The **USB Devices** item shows the auto-detected values. If no USB device is detected, the item shows **None**.

#### Legacy USB Support [Enabled]

- [Disabled] The USB devices can be used only for the BIOS setup program.
- [Enabled] Enables the support for USB devices on legacy operating systems (OS).
- [Auto] Allows the system to detect the presence of USB devices at startup. If detected, the USB controller legacy mode is enabled. If no USB device is detected, the legacy USB support is disabled.

#### Legacy USB3.0 Support [Enabled]

- [Disabled] Disables the function.
- [Enabled] Enables the support for USB 3.0 devices on legacy operating systems (OS).

#### EHCI Hand-off [Disabled]

- [Disabled] Disables the function.
- [Enabled] Enables the support for operating systems without an EHCI hand-off feature.

## 3.5.6 Onboard Devices Configuraton

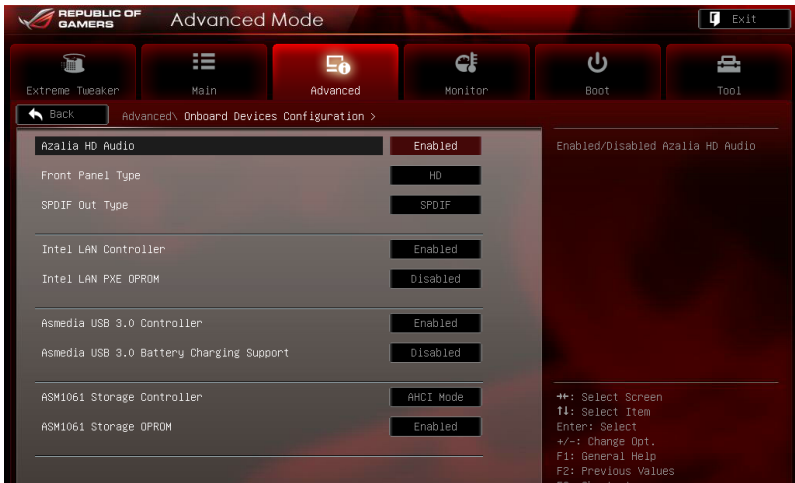

### Azalia HD Audio [Enabled]

[Disabled] Disables the controller.

[Enabled] Enables the High Definition Audio Controller.



The following two items appear only when you set the **Azalia HD Audio** item to [Enabled].

### Front Panel Type [HD]

Allows you to set the front panel audio connector (AAFP) mode to legacy AC97 or high-definition audio depending on the audio standard that the front panel audio module supports.

[HD] Sets the front panel audio connector (AAFP) mode to high definition audio.

[AC97] Sets the front panel audio connector (AAFP) mode to legacy AC97

### SPDIF Out Type [SPDIF]

[SPDIF] Sets to [SPDIF] for SPDIF audio output.

[HDMI] Sets to [HDMI] for HDMI audio output.

### Intel LAN Controller [Enabled]

[Disabled] Disables the controller.

[Enabled] Enables the Intel LAN controller.

### Intel LAN PXE OPROM [Disabled]

This item appears only when you set the previous item to [Enabled] and allows you to enable or disable the PXE OptionRom of the Intel LAN controller.

Configuration options: [Enabled] [Disabled]

### **Asmedia USB 3.0 Controller [Enabled]**

This item allows user to enable/disable the Asmedia USB 3.0 controller.  
Configuration options: [Disabled] [Enabled]

### **Asmedia USB 3.0 Battery Charging Support [Disabled]**

This item allows user to enable/disable the USB charging support of the Asmedia USB 3.0 controller. Configuration options: [Disabled] [Enabled]

### **ASM1061 Storage Controller [AHCI Mode]**

Allows you to enable or disable the ASM1061 storage controller.  
Configuration options: [Disabled] [IDE Mode] [AHCI Mode]



---

If you want to use the full function of the ASM1061 storage controller (ex. AHCI), we recommend that you set this item to [AHCI Mode] and install the **ASM1061 Controller Driver** from the motherboard support DVD.

---

### **ASM1061 Storage OPROM [Enabled]**

This item appears only when you set the previous item to [IDE Mode] or [AHCI Mode] and allows you to enable or disable the OptionRom of the ASM1061 storage controller.  
Configuration options: [Disabled] [Enabled]

## 3.5.7 APM

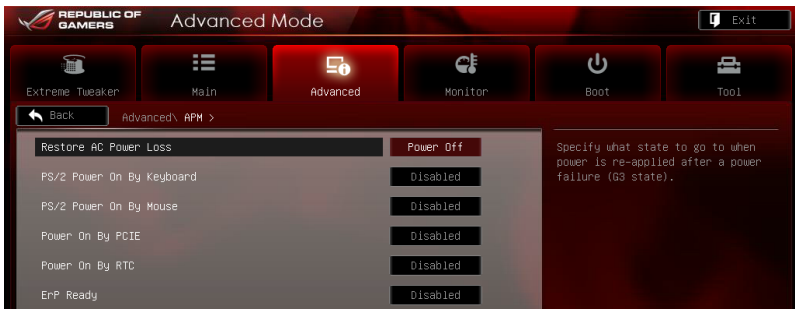

### Restore AC Power Loss [Power Off]

[Power On] The system goes into on state after an AC power loss.

[Power Off] The system goes into off state after an AC power loss.

[Last State] The system goes into either off or on state, whatever the system state was before the AC power loss.

### PS/2 Power on By Keyboard [Disabled]

Allows you to disable the Power On by keyboard function or set specific keys on the keyboard to turn on the system.

Configuration options: [Disabled] [Space Bar] [Ctrl-Esc] [Power Key]

### PS/2 Power on By Mouse [Disabled]

[Disabled] Disables the Power On by a mouse.

[Enabled] Enables the Power On by a mouse.

### Power On By PCIE [Disabled]

[Disabled] Disables the PCIE devices to generate a wake event.

[Enabled] Enables the PCIE devices to generate a wake event.

### Power On By RTC [Disabled]

[Disabled] Disables RTC to generate a wake event.

[Enabled] When set to [Enabled], the items **RTC Alarm Date (Days)** and **Hour/Minute/Second** will become user-configurable with set values.

### ErP Ready [Disabled]

This item allows user to switch off some power at S5 to get the system ready for ErP requirement. When set to Enabled, all other PME options will be switched off.

Configuration options: [Disabled] [Enabled]

## 3.6 Monitor menu

The Monitor menu displays the system temperature/power status, and allows you to change the fan settings.

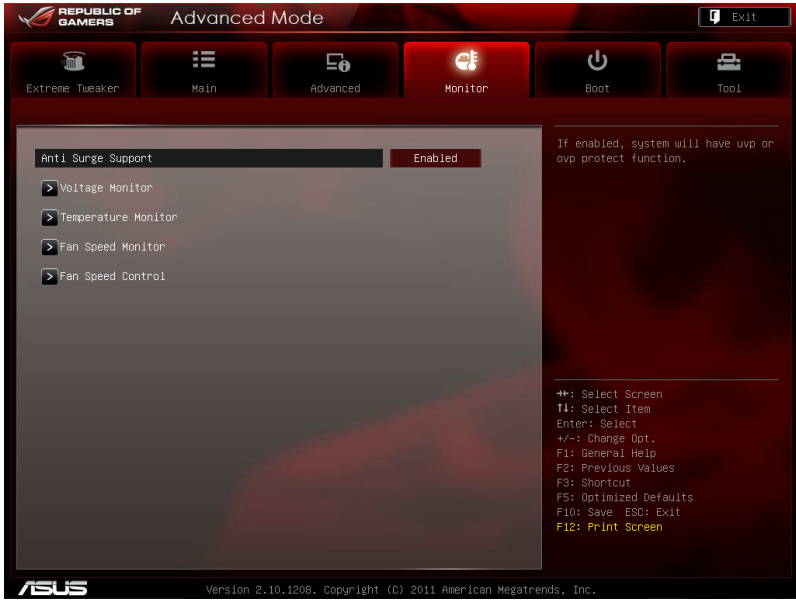

### Anti Surge Support [Enabled]

This item allows you to enable or disable the Anti Surge function.  
Configuration options: [Disabled] [Enabled]

### Voltage Monitor

CPU Voltage: 3.3V Voltage: 5V Voltage: 12V Voltage: VTT CPU Voltage:  
CPU VCCSA Voltage: CPU PLL Voltage, DRAM AB/CD Voltage: PCH 1.1 Voltage:  
PCH 1.5 Voltage: 2nd VTTCPU Voltage

The onboard hardware monitor automatically detects the voltage output through the onboard voltage regulators.

### Temperature Monitor

CPU Temperature: MB Temperature: PCH Temperature: OPT1/2/3 Temperature[xxx°C/xxx°F]

The onboard hardware monitor automatically detects and displays the CPU, motherboard, and the assigned devices temperatures. Select [Ignored] if you do not wish to display the detected temperatures.



## Fan Speed Monitor

CPU FAN Speed; CPU OPT Speed; Chassis FAN1/2/3 Speed; OPT FAN 1/2/3 Speed [xxxRPM] or [Ignored] / [N/A]

The onboard hardware monitor automatically detects and displays the CPU fan, chassis fan, and optional fan speed in rotations per minute (RPM). If any of the fans is not connected to the motherboard, the field shows [N/A]. These items are not user-configurable.

## Fan Speed Control

CPU Q-Fan Control [Enabled]

Allows you to enable or disable the CPU fan controller.

[Disabled] Disables the CPU Q-fan controller.

[Enabled] Enables the CPU Q-fan controller.



---

The following three items appear when you enable the CPU Fan Control feature.

---

CPU Fan Speed Low Limit [600 RPM]

Allows you to set the low speed limit of the CPU fan and the system sends warning message when the fan speed drops below the set value.

Configuration options: [Ignored] [200 RPM] [300 RPM] [400 RPM] [500 RPM] [600 RPM]

CPU Fan Profile [Standard]

Allows you to set the appropriate performance level of the CPU fan.

[Standard] Sets to [Standard] to make the chassis fan automatically adjust depending on the CPU temperature.

[Silent] Sets to [Silent] to minimize the fan speed for quiet CPU fan operation.

[Turbo] Set to [Turbo] to achieve maximum CPU fan speed.

[Manual] Sets to [Manual] to display more items for you to manually adjust the CPU upper/lower temperature, and CPU fan upper/lower duty cycle.



---

The following four items appear only when you set **CPU Fan Profile** to [Manual].

---

### **CPU Upper Temperature [70]**

Use the <+> and <-> keys to adjust the upper limit of the CPU temperature. The values range from 20°C to 75°C.

### **CPU Fan Max. Duty Cycle(%) [100]**

Use the <+> and <-> keys to adjust the maximum CPU fan duty cycle. The values range from 1% to 100%. When the CPU temperature reaches the upper limit, the CPU fan will operate at the maximum duty cycle.

### **CPU Lower Temperature [20]**

Displays the lower limit of the CPU temperature.

### **CPU Fan Min. Duty Cycle(%) [20]**

Use the <+> and <-> keys to adjust the minimum CPU fan duty cycle. The values range from 0% to 100%. When the CPU temperature is under 40°C, the CPU fan will operate at the minimum duty cycle.

### **Chassis Q-Fan Control [Enabled]**

[Disabled] Disables the Chassis Q-Fan control feature.

[Enabled] Enables the Chassis Q-Fan control feature.

### **Chassis Fan Speed Low Limit [600 RPM]**

This item appears only when you enable the **Chassis Q-Fan Control** feature and allows you to disable or set the chassis fan warning speed.

Configuration options: [Ignore] [200 RPM] [300 RPM] [400 RPM] [500 RPM] [600 RPM]

#### *Chassis Fan Profile [Standard]*

This item appears only when you enable the **Chassis Q-Fan Control** feature and allows you to set the appropriate performance level of the chassis fan.

[Standard] Sets to [Standard] to make the chassis fan automatically adjust depending on the chassis temperature.

[Silent] Sets to [Silent] to minimize the fan speed for quiet chassis fan operation.

[Turbo] Sets to [Turbo] to achieve maximum chassis fan speed.

[Manual] Sets to [Manual] to assign detailed fan speed control parameters.



---

The following four items appear only when you set **Chassis Fan Profile** to [Manual].

---

### **Chassis Upper Temperature [70]**

Use the <+> and <-> keys to adjust the upper limit of the CPU temperature. The values range from 40°C to 90°C.

### **Chassis Fan Max. Duty Cycle(%) [100]**

Use the <+> and <-> keys to adjust the maximum chassis fan duty cycle. The values range from 60% to 100%. When the chassis temperature reaches the upper limit, the chassis fan will operate at the maximum duty cycle.

### **Chassis Lower Temperature [40]**

Displays the lower limit of the chassis temperature.

### **Chassis Fan Min. Duty Cycle(%) [60]**

Use the <+> and <-> keys to adjust the minimum chassis fan duty cycle. The values range from 0% to 100%. When the chassis temperature is under 40°C, the chassis fan will operate at the minimum duty cycle.

### OPT Fan 1/2/3 Control [Disabled]

Allows you to select the optional fan control mode. When this item is set to [Duty Mode], you can configure the **OPT Fan 1/2/3. Duty Cycle()** item. When this item is set to [Profile Mode], you can configure the **OPT Fan 1/2/3 Profile** item. If you set this item to [User Mode], you are allowed to configure the **OPT Fan 1/2/3 Low Speed Temp** and **OPT Fan 1/2/3 Full Speed Temp** items. Configuration options: [Disabled] [Duty Mode] [Profile Mode] [User Mode]

OPT Fan 1/2/3. Duty Cycle() [50%]

Allows you to set the fan duty cycle. Configuration options: [50%] [60%] [70%] [80%] [90%]

OPT Fan 1/2/3 Profile [Silent]

Allows you to select a PCH fan profile. Configuration options: [Performance] [Optional] [Silent]

OPT FAN 1/2/3 Low Speed Temp [25°C]

Allows you to set the temperature at which the power fan rotates at low speed.  
Configuration options: [25°C] [30°C] [35°C] [40°C]

OPT FAN 1/2/3 Full Speed Temp [60°C]

Allows you to set the temperature at which the power fan rotates at full speed.  
Configuration options: [60°C] [70°C] [80°C] [90°C]

## 3.7 Boot menu

The Boot menu items allow you to change the system boot options.

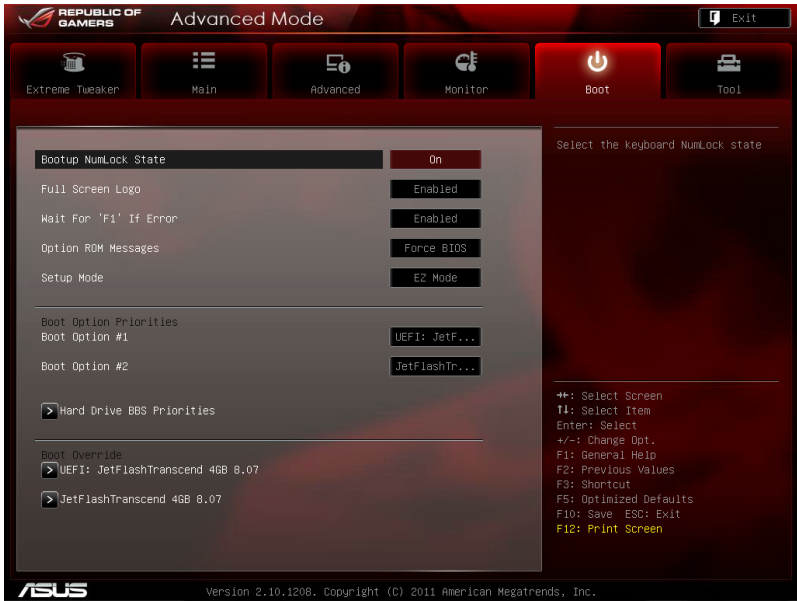

### Bootup NumLock State [On]

[On] Sets the power-on state of the NumLock to [On].

[Off] Sets the power-on state of the NumLock to [Off].

### Full Screen Logo [Enabled]

[Enabled] Enables the full screen logo display feature.

[Disabled] Disables the full screen logo display feature.



Set this item to [Enabled] to use the ASUS MyLogo 2™ feature.

### Wait For 'F1' If Error [Enabled]

[Disabled] Disables this function.

[Enabled] The system waits for the <F1> key to be pressed when error occurs.

### Option ROM Messages [Force BIOS]

[Force BIOS] The third-party ROM messages will be forced to display during the boot sequence.

[Keep Current] The third-party ROM messages will be displayed only if the third-party manufacturer had set the add-on device to do so.

## Setup Mode [Advanced Mode]

[Advanced Mode] Sets Advanced Mode as the default screen for entering the BIOS setup program.

[EZ Mode] Sets EZ Mode as the default screen for entering the BIOS setup program.

## Boot Option Priorities

These items specify the boot device priority sequence from the available devices. The number of device items that appears on the screen depends on the number of devices installed in the system.



- 
- To select the boot device during system startup, press <F8> when ASUS Logo appears.
  - To access Windows OS in Safe Mode, press <F8> after POST.
- 

## Boot Override

These items displays the available devices. The number of device items that appears on the screen depends on the number of devices installed in the system. Click an item to start booting from the selected device.

## 3.8 Tools menu

The Tools menu items allow you to configure options for special functions. Select an item then press <Enter> to display the submenu.

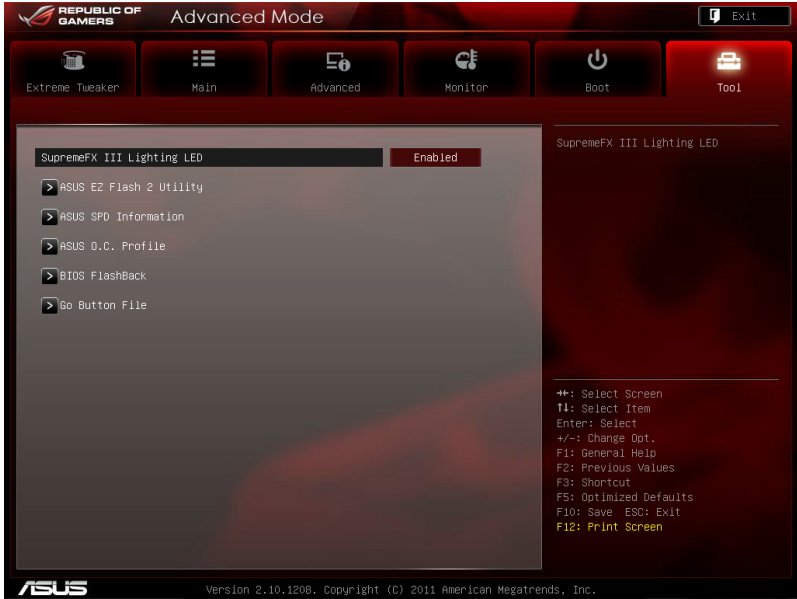

### 3.8.1 ASUS EZ Flash 2 Utility

Allows you to run ASUS EZ Flash 2 Utility. When you press <Enter> to start the application.



---

For more details, refer to [section 3.10.2 ASUS EZ Flash 2 Utility](#).

---

### 3.8.2 ASUS SPD Information

Allows you to get DRAM SPD information.



### 3.8.3 ASUS O.C. Profile

This item allows you to store or load multiple BIOS settings.

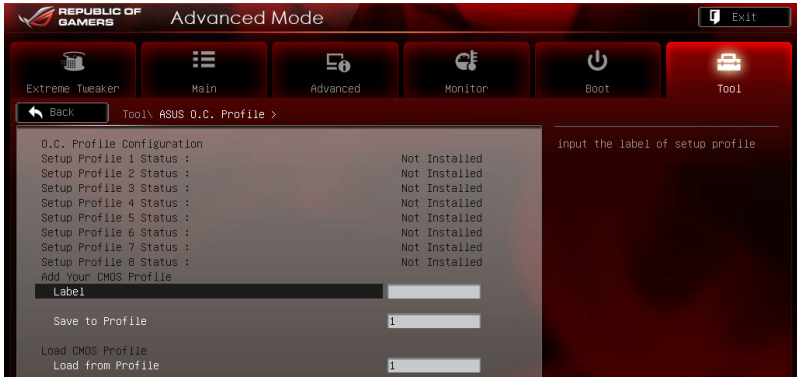

The **Setup Profile Status** items show **Not Installed** if no profile is created.

#### Label

Allows you to input the label of setup profile.

#### Save to Profile

Allows you to save the current BIOS settings to the BIOS Flash, and create a profile. Key in a profile number from one to eight, press <Enter>, and then select **Yes**.

#### Load from Profile

Allows you to load the previous BIOS settings saved in the BIOS Flash. **Key** in the profile number that saved your BIOS settings, press <Enter>, and then select **Yes**.



- DO NOT shut down or reset the system while updating the BIOS to prevent the system boot failure!
- We recommend that you update the BIOS file only coming from the same memory/CPU configuration and BIOS version.



### 3.8.4 BIOS FlashBack

This item allows you to configure BIOS FlashBack settings.

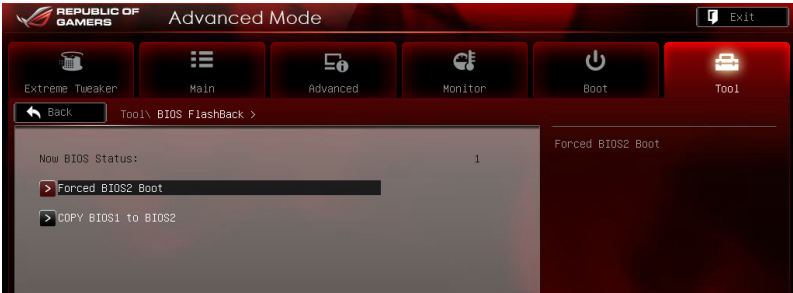

#### Forced BIOS2 Boot

Allows you to boot the system using BIOS chip 2.

#### COPY BIOS1 to BIOS2

Only current operating BIOS can be mirrored. System will enter the soft-off state. After BIOS backup is finished, system will auto power-on.

#### Forced BIOS1 Boot

Allows you to boot the system using BIOS chip 1.

#### COPY BIOS2 to BIOS1

Only current operating BIOS can be mirrored. System will enter the soft-off state. After BIOS backup is finished, system will auto power-on.

### 3.8.5 GO Button File

This menu allows you to set the GO Button files, and load the desired GO Button file.

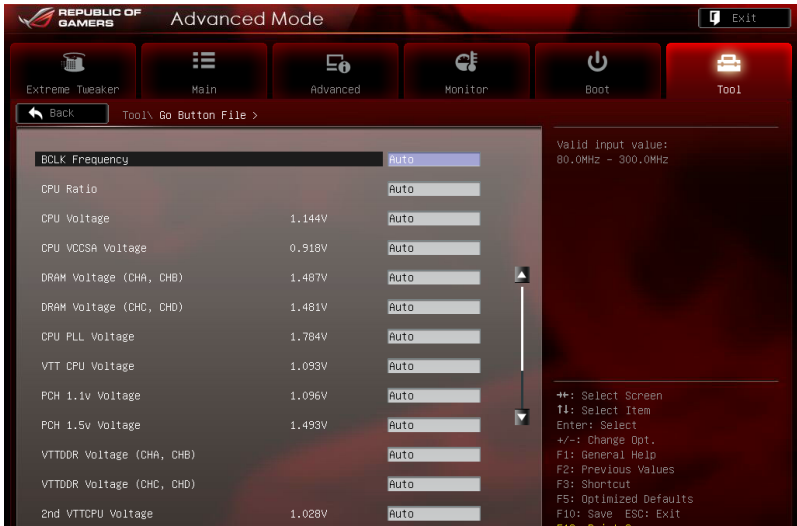

Scroll down to display the following items:



**BCLK Frequency; CPU Ratio; CPU Voltage; CPU VCCSA Voltage; DRAM Voltage (CHA, CHB/CHC, CHD); CPU PLL Voltage; VTT CPU Voltage; PCH 1.1v Voltage; PCH 1.5v Voltage; VTTDDR Voltage (CHA, CHB/CHC, CHD); 2nd VTTCPU Voltage; PCH 1.1VG Voltage.**

Allows you to use the <+> and <-> keys to adjust the values for each item. Refer to **3.3 Extreme Tweaker Menu** for details.

#### Load Default

Allows you to load default settings.

#### Save Above Settings

Allows you to save the adjusted values for specific items as a GO Button file.

#### Load from EEPROM settings

Allows you to load from EEPROM setting.

## 3.9 Exit menu

The Exit menu items allow you to load the optimal default values for the BIOS items, and save or discard your changes to the BIOS items. You can access the **EZ Mode** from the Exit menu.



### Load Optimized Defaults

This option allows you to load the default values for each of the parameters on the Setup menus. When you select this option or if you press <F5>, a confirmation window appears. Select **Yes** to load the default values.

### Load Safe Defaults

This option allows you to load the safest default values for each of the parameters on the Setup menus. Select **Yes** to load the default values.

### Save Changes & Reset

Once you are finished making your selections, choose this option from the Exit menu to ensure the values you selected are saved. When you select this option or if you press <F10>, a confirmation window appears. Select **Yes** to save changes and exit.

### Discard Changes & Exit

This option allows you to exit the Setup program without saving your changes. When you select this option or if you press <Esc>, a confirmation window appears. Select **Yes** to discard changes and exit.

### ASUS EZ Mode

This option allows you to enter the EZ Mode screen.

### Launch EFI Shell from filesystem device

This option allows you to attempt to launch the EFI Shell application (shellx64.efi) from one of the available filesystem devices.

## 3.10 Updating BIOS

The ASUS website publishes the latest BIOS versions to provide enhancements on system stability, compatibility, or performance. However, BIOS updating is potentially risky. If there is no problem using the current version of BIOS, **DO NOT manually update the BIOS**. Inappropriate BIOS updating may result in the system's failure to boot. Carefully follow the instructions of this chapter to update your BIOS if necessary.



---

Visit the ASUS website ([www.asus.com](http://www.asus.com)) to download the latest BIOS file for this motherboard.

---

The following utilities allow you to manage and update the motherboard BIOS setup program.

1. **ASUS Update:** Updates the BIOS in Windows® environment.
2. **ASUS EZ Flash 2:** Updates the BIOS using a USB flash drive.
3. **ASUS CrashFree BIOS 3:** Restores the BIOS using the motherboard support DVD or a USB flash drive when the BIOS file fails or gets corrupted.
4. **ASUS BIOS Updater:** Updates and backups the BIOS in DOS environment using the motherboard support DVD and a USB flash disk drive.
5. **USB BIOS Flashback:** Updates the BIOS under standby power using a USB flash disk drive without entering BIOS or OS.

Refer to the corresponding sections for details on these utilities.



---

Save a copy of the original motherboard BIOS file to a USB flash disk in case you need to restore the BIOS in the future. Copy the original motherboard BIOS using the **ASUS Update** or **BIOS Updater** utilities.

---

### 3.10.1 ASUS Update utility

The ASUS Update is a utility that allows you to manage, save, and update the motherboard BIOS in Windows® environment. The ASUS Update utility allows you to:

- Update the BIOS directly from the Internet
- Download the latest BIOS file from the Internet
- Update the BIOS from an updated BIOS file
- Save the current BIOS file
- View the BIOS version information

This utility is available in the support DVD that comes with the motherboard package.



---

ASUS Update requires an Internet connection either through a network or an Internet Service Provider (ISP).

---

### Launching ASUS Update

After installing AI Suite II from the motherboard support DVD, launch ASUS Update by clicking **Update > ASUS Update** on the AI Suite II main menu bar.



---

Quit all Windows® applications before you update the BIOS using this utility.

---

## Updating the BIOS through the Internet

To update the BIOS through the Internet:

1. From the ASUS Update screen, select **Update BIOS from Internet**, and then click **Next**.

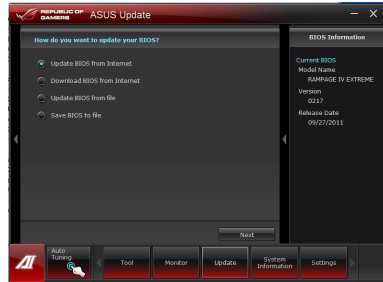

2. Select the ASUS FTP site nearest you to avoid network traffic.

If you want to enable the BIOS downgradable function and auto BIOS backup function, check the checkboxes before the two items on the screen.

3. Select the BIOS version that you want to download. Click **Next**.

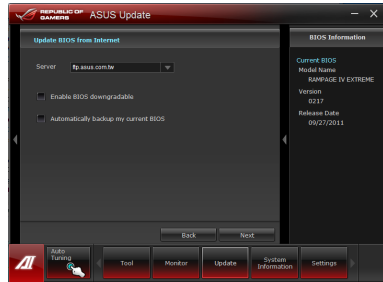

4. You can decide whether to change the BIOS boot logo, which is the image appearing on screen during the Power-On Self-Tests (POST). Click **Yes** if you want to change the boot logo or **No** to continue.



5. Click **Browse** to locate your desired picture file.

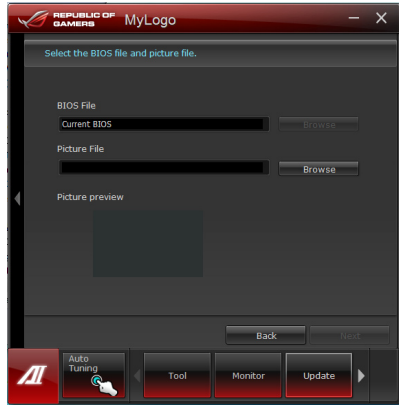

6. Adjust the picture resolution if needed and click **Next** to continue.



7. Follow the onscreen instructions to complete the update process.

## Updating the BIOS through a BIOS file

To update the BIOS through a BIOS file:

1. From the ASUS Update screen, select **Update BIOS from file**, and then click **Next**.



2. Locate the BIOS file from the **Open** window, click **Open**, and click **Next**.
3. You can decide whether to change the BIOS boot logo. Click **Yes** if you want to change the boot logo or **No** to continue.

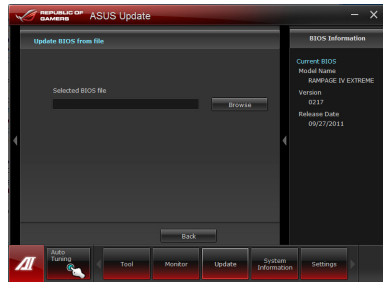

4. Follow the onscreen instructions to complete the update process.

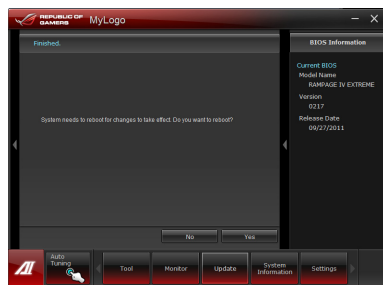

- The screenshots in this section are for reference only. The actual BIOS information vary by models.
- Refer to the software manual in the support DVD or visit the ASUS website at [www.asus.com](http://www.asus.com) for detailed software configuration.

### 3.10.2 ASUS EZ Flash 2 Utility

The ASUS EZ Flash 2 Utility feature allows you to update the BIOS without having to use a bootable floppy disk or an OS-based utility.



Before you start using this utility, download the latest BIOS from the ASUS website at [www.asus.com](http://www.asus.com).

To update the BIOS using EZ Flash 2 Utility:

1. Insert the USB flash disk that contains the latest BIOS file to the USB port.
2. Enter the Advanced Mode of the BIOS setup program. Go to the **Tool** menu to select **ASUS EZ Flash 2 Utility** and press <Enter> to enable it.

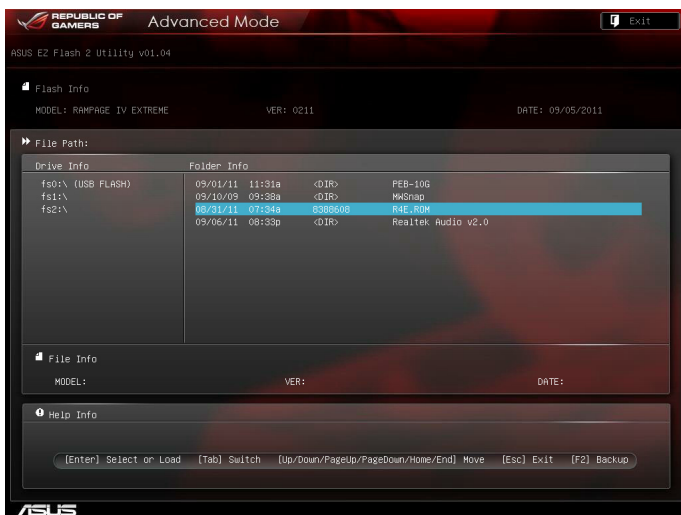

3. Press <Tab> to switch to the **Drive** field.
4. Press the Up/Down arrow keys to find the USB flash disk that contains the latest BIOS, and then press <Enter>.
5. Press <Tab> to switch to the **Folder Info** field.
6. Press the Up/Down arrow keys to find the BIOS file, and then press <Enter> to perform the BIOS update process. Reboot the system when the update process is done.



- This function can support devices such as a USB flash disk with FAT 32/16 format and single partition only.
- DO NOT shut down or reset the system while updating the BIOS to prevent system boot failure!



Ensure to load the BIOS default settings to ensure system compatibility and stability. Select the **Load Optimized Defaults** item under the **Exit** menu. See section 3.9 Exit Menu for details.



### 3.10.3 ASUS CrashFree BIOS 3 utility

The ASUS CrashFree BIOS 3 utility is an auto recovery tool that allows you to restore the BIOS file when it fails or gets corrupted during the updating process. You can restore a corrupted BIOS file using the motherboard support DVD or a USB flash drive that contains the BIOS file.



---

The BIOS file in the motherboard support DVD may be older than the BIOS file published on the ASUS official website. If you want to use the newer BIOS file, download the file at [support.asus.com](http://support.asus.com) and save it to a USB flash drive.

---

#### Recovering the BIOS

To recover the BIOS:

1. Turn on the system.
2. Insert the motherboard support DVD to the optical drive, or the USB flash drive containing the BIOS file to the USB port.
3. The utility automatically checks the devices for the BIOS file. When found, the utility reads the BIOS file and enters ASUS EZ Flash 2 utility automatically.
4. The system requires you to enter BIOS Setup to recover BIOS setting. To ensure system compatibility and stability, we recommend that you press <F5> to load default BIOS values.



---

**DO NOT** shut down or reset the system while updating the BIOS! Doing so can cause system boot failure!

---

### 3.10.4 ASUS BIOS Updater

The ASUS BIOS Updater allows you to update BIOS in DOS environment. This utility also allows you to copy the current BIOS file that you can use as a backup when the BIOS fails or gets corrupted during the updating process.



The succeeding utility screens are for reference only. The actual utility screen displays may not be same as shown.

#### Before updating BIOS

1. Prepare the motherboard support DVD and a USB flash drive in FAT32/16 format and single partition.
2. Download the latest BIOS file and BIOS Updater from the ASUS website at <http://support.asus.com> and save them on the USB flash drive.



- NTFS is not supported under DOS environment. Do not save the BIOS file and BIOS Updater to a hard disk drive or USB flash drive in NTFS format.
- Do not save the BIOS file to a floppy disk due to low disk capacity.

3. Turn off the computer and disconnect all SATA hard disk drives (optional).

#### Booting the system in DOS environment

1. Insert the USB flash drive with the latest BIOS file and BIOS Updater to the USB port.
2. Boot your computer. When the ASUS Logo appears, press <F8> to show the **BIOS Boot Device Select Menu**. Insert the support DVD into the optical drive and select the optical drive as the boot device.

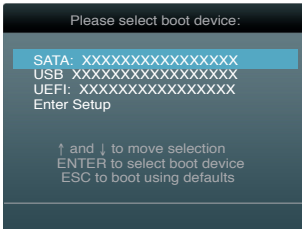

3. When the **Make Disk** menu appears, select the **FreeDOS command prompt** item by pressing the item number.
4. At the FreeDOS prompt, type `d:` and press <Enter> to switch the disk from Drive C (optical drive) to Drive D (USB flash drive).

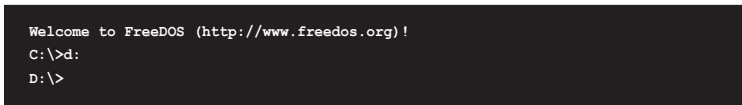

## Backing up the current BIOS

To backup the current BIOS file using the BIOS Updater



Ensure that the USB flash drive is not write-protected and has enough free space to save the file.

1. At the FreeDOS prompt, type `bupdater /o [filename]` and press <Enter>.

```
D:\>bupdater /oO1DBIOS1.rom
```

Filename Extension

The [filename] is any user-assigned filename with no more than eight alphanumeric characters for the filename and three alphanumeric characters for the extension.

2. The BIOS Updater backup screen appears indicating the BIOS backup process. When BIOS backup is done, press any key to return to the DOS prompt.

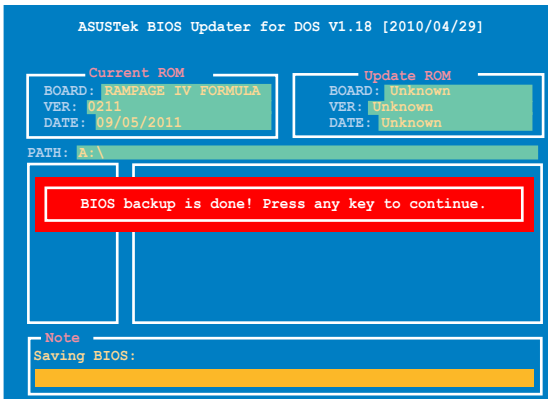

## Updating the BIOS file

To update the BIOS file using BIOS Updater

1. At the FreeDOS prompt, type `bupdater /pc /g` and press <Enter>.

```
D:\>bupdater /pc /g
```

2. The BIOS Updater screen appears as below.

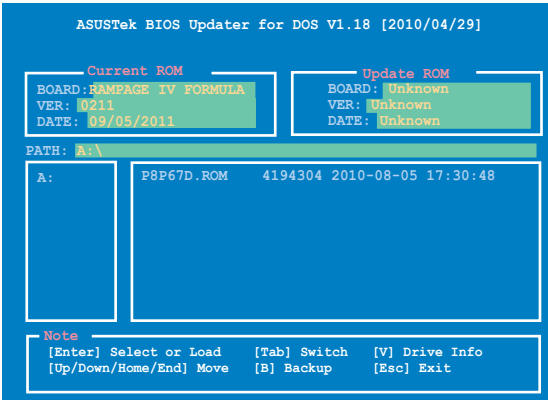

3. Press <Tab> to switch between screen fields and use the <Up/Down/Home/End> keys to select the BIOS file and press <Enter>. BIOS Updater checks the selected BIOS file and prompts you to confirm BIOS update.



4. Select **Yes** and press <Enter>. When BIOS update is done, press <ESC> to exit BIOS Updater. Restart your computer.



---

DO NOT shut down or reset the system while updating the BIOS to prevent system boot failure!

---

- For BIOS Updater version 1.04 or later, the utility automatically exits to the DOS prompt after updating BIOS.
  - Ensure to load the BIOS default settings to ensure system compatibility and stability. Select the **Load Optimized Defaults** item under the **Exit BIOS** menu. See Chapter 3 of your motherboard user manual for details.
  - Ensure to connect all SATA hard disk drives after updating the BIOS file if you have disconnected them.
-

### 3.10.5 USB BIOS Flashback

The USB BIOS Flashback allows user to update the BIOS without entering the BIOS or the operating system by using a USB flash disk drive under standby power.

1. Download the latest BIOS file from the ASUS website
2. Extract and rename the BIOS image file to “**R4F.ROM**”
3. Copy “**R4F.ROM**” to the root directory of the USB flash disk drive
4. Turn off the system and connect the USB flash drive to the **ROG Connect port** (the white USB 2.0 port) at the rear panel of the motherboard
5. Hold the **ROG Connect button** until the LED begins to blink, then release
6. Wait until the LED stops to blink, then the BIOS flash will be completed.

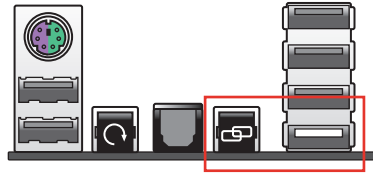

- 
- This function can support devices such as a USB flash disk with FAT 32/16 format and single partition only.
  - DO NOT unplug the power of the system while updating the BIOS to prevent system boot failure!
-



# Chapter 4

## 4.1 Installing an operating system

This motherboard supports Windows® XP/ 64-bit XP/ Vista / 64-bit Vista / 7 / 64-bit 7 operating systems (OS). Always install the latest OS version and corresponding updates to maximize the features of your hardware.



- Motherboard settings and hardware options vary. Use the setup procedures presented in this chapter for reference only. Refer to your OS documentation for detailed information.
- Ensure that you install the Windows® XP Service Pack 3 or later versions before installing the drivers for better compatibility and system stability.

## 4.2 Support DVD information

The support DVD that comes with the motherboard package contains the drivers, software applications, and utilities that you can install to avail all motherboard features.



The contents of the support DVD are subject to change at any time without notice. Visit the ASUS website at [www.asus.com](http://www.asus.com) for updates.

### 4.2.1 Running the support DVD

Place the support DVD into the optical drive. The DVD automatically displays the Drivers menu if Autorun is enabled in your computer. Click each menu tab and select the items you want to install.

The Manual menu contains the list of supplementary user manuals. Click an item to open the folder of the user manual.

The Drivers menu shows the available device drivers if the system detects installed devices. Install the necessary drivers to use the devices.

The Utilities menu shows the applications and other software that the motherboard supports.

The Video menu contains the list of supplementary videos. Click the video titles to watch ROG users' outstanding performances with ROG motherboards.

Click the Contact tab to display the ASUS contact information.

Click an icon to display DVD/motherboard information

Click an item to install

The screenshot shows the ASUS support DVD menu. At the top, there is a navigation bar with tabs for Drivers, Utilities, Manual, Video, Contact, and Specials. Below the navigation bar is a large red button labeled 'ASUS InstAll'. To the right of this button is a section labeled 'MB' with a CD icon and a document icon, and the text 'Please select items to install:'. Below this is a list of drivers: Google Toolbar, Google Chrome Browser, Intel Chipset Driver, Management Engine Interface, Realtek Audio Driver, Intel LAN Driver, Asmedia USB 3.0 Driver, ASUS Bluetooth Driver, Intel Rapid Storage Technology enterpri..., and Asmedia SATA Controller Driver. Arrows from text boxes point to various elements of the interface.



If Autorun is NOT enabled in your computer, browse the contents of the support DVD to locate the file ASSETUP.EXE from the BIN folder. Double-click the ASSETUP.EXE to run the DVD.

## 4.2.2 Obtaining the software manuals

The software manuals are included in the support DVD. Follow the instructions below to get the necessary software manuals.



The software manual files are in Portable Document Format (PDF). Install the Adobe® Acrobat® Reader from the Utilities menu before opening the files.

1. Click on the **Manual** tab. Click on **ASUS Motherboard Utility Guide** from the manual list on the left.



2. The **Manual** folder of the support DVD appears. Double-click the folder of your selected software.

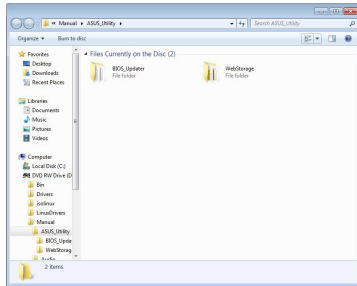

3. Some software manuals are provided in different languages. Double-click the language to show the software manual.

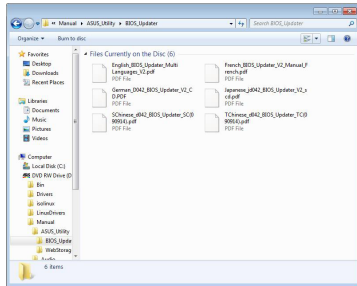

The screenshots in this section are for reference only. The actual software manuals containing in the support DVD vary by models.



## 4.3 Software information

Most of the applications in the support DVD have wizards that will conveniently guide you through the installation. View the online help or readme file that came with the software application for more information.

### 4.3.1 AI Suite II

AI Suite II is an all-in-one interface that integrates several ASUS utilities and allows users to launch and operate these utilities simultaneously.

#### Installing AI Suite II

To install AI Suite II on your computer

1. Place the support DVD to the optical drive. The Drivers installation tab appears if your computer has enabled the Autorun feature.
2. Click on the Utilities tab, then click **AI Suite II**.
3. Follow the onscreen instructions to complete installation.

#### Using AI Suite II

AI Suite II automatically starts when you enter the Windows® operating system (OS). The AI Suite II icon appears in the Windows® notification area. Click on the icon to open the AI Suite II main menu bar.

Click on each button to select and launch a utility, to monitor the system, to update the motherboard BIOS, to display the system information, and to customize the settings of AI Suite II.

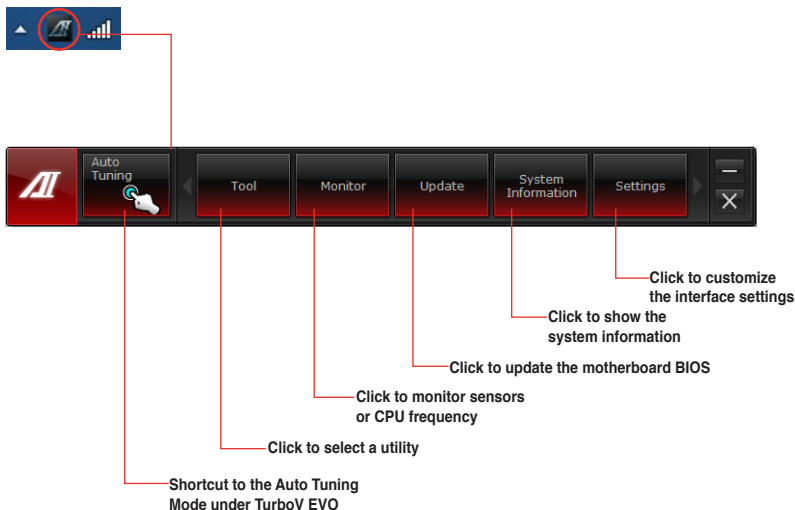

- The **Auto Tuning** button appears only on models with the TurboV EVO function.
- The applications in the Tool menu vary with models.
- The screenshots of AI Suite II in this user manual are for reference only. The actual screenshots vary with models.
- Refer to the software manual in the support DVD or visit the ASUS website at [www.asus.com](http://www.asus.com) for detailed software configuration.

### 4.3.2 TurboV EVO

ASUS TurboV EVO introduces **TurboV** that allows you to manually adjust the CPU frequency and related voltages as well as **Auto Tuning** function that offers automatic and easy overclocking and system level up. After installing AI Suite II from the motherboard support DVD, launch TurboV EVO by clicking **Tool > TurboV EVO** on the AI Suite II main menu bar.



Refer to the software manual in the support DVD or visit the ASUS website at [www.asus.com](http://www.asus.com) for detailed software configuration.

#### TurboV EVO

TurboV EVO allows you to overclock the BCLK frequency, CPU voltage, IMC voltage, and DRAM Bus voltage in Windows® environment and takes effect in real-time without exiting and rebooting the OS.



Refer to the CPU documentation before adjusting CPU voltage settings. Setting a high voltage may damage the CPU permanently, and setting a low voltage may make the system unstable.



For system stability, all changes made in TurboV EVO will not be saved to BIOS settings and will not be kept on the next system boot. Use the **Save Profile** function to save your customized overclocking settings and manually load the profile after Windows starts.

Click to select mode

Load profile Target values

Current values

Click to show settings

Click to restore all start-up settings

Save the current settings as a new profile

Voltage Adjustment bars

Undoes all changes without applying

Applies all changes immediately

## Using Advanced Mode

Click on the **Advanced Mode** tab to adjust the advanced voltage settings.



## CPU Ratio

Allows you to manually adjust the CPU ratio.

1. Click the **CPU Ratio** tab.
2. Click **ON** to activate the CPU Ratio function. The system automatically reboots for the changes to take effect.
3. After system reboot, launch TurboV EVO again, and then click the CPU Ratio tab. Drag the adjustment bar upwards or downwards to the desired value.
4. Click **Apply** to make the change take effect.



- Set the **CPU Ratio Setting** item in BIOS to [Auto] before using the CPU Ratio function in TurboV. Refer to Chapter 3 of your motherboard user manual for details.
- The CPU Ratio bars show the status of the CPU cores, which vary with your CPU model.

## CPU Strap

Allows you to manually adjust CPU Strap.

1. Click on the **CPU Strap** tab.
2. Click on the adjustment bar to the desired value. The graph on the right will change value accordingly.
3. Click on **Apply** to make the change take effect.



- Applied settings in CPU Ratio affect CPU Strap results.
- The value on the CPU Strap diagram varies with your CPU model.

## Auto Tuning

ASUS TurboV EVO includes two auto tuning modes, providing the most flexible auto-tuning options.



- The overlocking result varies with the CPU model and the system configuration.
- To prevent overheating from damaging the motherboard, a better thermal environment is strongly recommended.

- **Fast Tuning**: fast CPU overlocking
- **Extreme Tuning**: extreme overlocking for CPU and memory

### Using Fast Tuning

1. Click the **Auto Tuning** tab and then click **Fast**.
2. Read through the warning messages and click **OK** to start auto-overlocking.



3. TurboV EVO automatically overclocks the CPU, saves BIOS settings and restarts the system. After re-entering Windows, a message appears indicating auto tuning success. Click **OK** to exit.

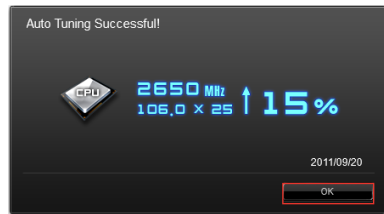

### Using Extreme Tuning

1. Click the **Auto Tuning** tab and then click **Extreme**.
2. Read through the warning messages and click **OK** to start auto-overclocking.



3. TurboV EVO automatically overclocks the CPU and memory and restarts the system. After re-entering Windows, a message appears indicating the current overclocking result. To keep the result, click **Stop**.

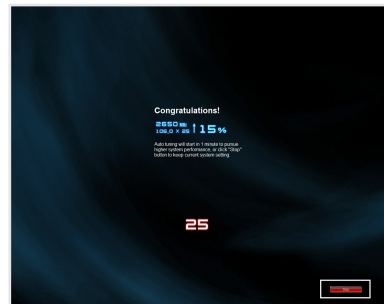

4. If you did not click **Stop** in the previous step, TurboV EVO automatically starts further system overclocking and stability test. An animation appears indicating the overclocking process. Click **Stop** if you want to cancel the Overclocking process.



5. TurboV EVO automatically adjusts and saves BIOS settings and restarts the system. After re-entering Windows, a message appears indicating auto tuning success. Click **OK** to exit.

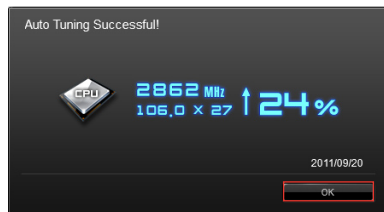

### 4.3.3 DIGI+ Power Control

DIGI+ PowerControl allows you to adjust VRM voltage and frequency modulation to enhance reliability and stability. It also provides the highest power efficiency, generating less heat to longer component lifespan and minimize power loss.

After installing AI Suite II from the motherboard support DVD, launch DIGI+ Power Control by clicking **Tool > DIGI+ Power Control** on the AI Suite II main menu bar.

Select **CPU Power** or **DRAM Power** to adjust the power control settings.

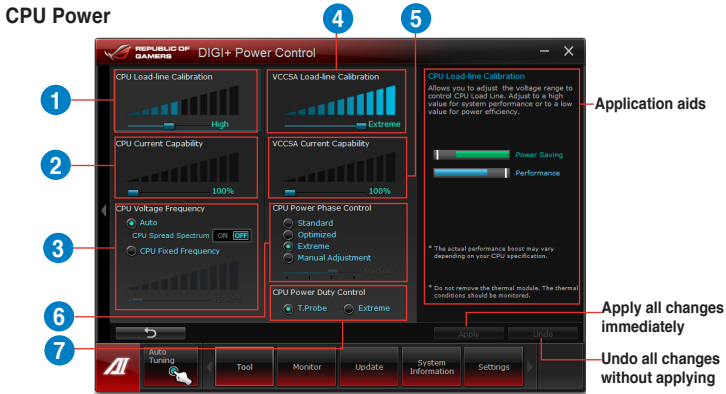

Function no.	Function description
1	<b>CPU Load-line Calibration</b> It allows you to adjust the voltage settings and control the system temperature. Higher load-line calibration could get higher voltage and good overclocking performance but increases the CPU and VRM thermal.
2	<b>CPU Current Capability</b> CPU Current Capability provides wider total power range for overclocking. A higher value setting gets higher VRM power consumption delivery.
3	<b>CPU Voltage Frequency</b> Switching frequency will affect the VRM transient response and component thermal. Higher frequency gets quicker transient response.
4	<b>VCCSA Load-line Calibration</b> The behavior of the DRAM Controller is decided by the VCCSA Load-line. Set to a higher value for system performance, or to a lower value for better thermal solution.
5	<b>VCCSA Current Capability</b> A higher value brings wider total DRAM Controller power range and extends the overclocking frequency range simultaneously.
6	<b>CPU Power Phase Control</b> Increase phase number under heavy system loading to get more transient and better thermal performance. Reduce phase number under light system loading to increase VRM efficiency.
7	<b>CPU Power Duty Control</b> CPU Power Duty Control adjusts the current of every VRM phase and the thermal of every phase component.

## DRAM Power

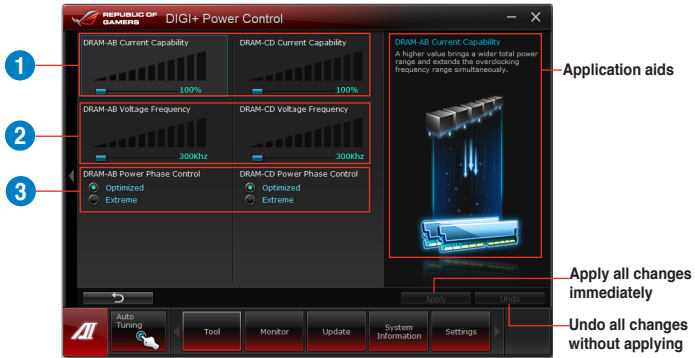

Function no.	Function description
1	<b>DRAM Current Capability</b> A higher value brings a wider total power range and extends the overclocking frequency range simultaneously.
2	<b>DRAM Voltage Frequency</b> Allows you to adjust the DRAM switching frequency for system stability or to increase OC Range.
3	<b>DRAM Power Phase Control</b> Set Manual Adjustment to faster phase response to increase system performance or to slower phase response to increase DRAM power efficiency.



- The actual performance boost may vary depending on your CPU specification.
- Do not remove the thermal module. The thermal conditions should be monitored.

### 4.3.4 EPU

EPU is an energy-efficient tool that satisfies different computing needs. This utility provides several modes that you can select to save system power. Selecting Auto mode will have the system shift modes automatically according to current system status. You can also customize each mode by configuring settings like CPU frequency, GPU frequency, vCore Voltage, and Fan Control.

#### Launching EPU

After installing AI Suite II from the motherboard support DVD, launch EPU by clicking **Tool > EPU** on the AI Suite II main menu bar.

The screenshot shows the EPU application window. At the top, it says 'REPUBLIC OF GAMERS EPU'. Below this, there are three mode selection buttons: 'Auto', 'High performance', and 'Max. power saving'. The 'Auto' mode is currently selected. In the center, there is a pentagonal radar chart with five points labeled: 'Tranquility', 'Performance', 'Reliability', 'Energy Saved', and 'Convenience'. Below the radar chart is a 'Configurations' button. On the right side, there is an 'EPU Status' panel with a 'Sensor' dropdown. It contains several icons for system components: CPU, HDD, Fan, Chipset, Memory, and VGA. The 'VGA' icon is highlighted with a blue dot. Below these icons, it shows 'Reduced CO2 Emission' as '0.000 mg'. There is a 'Time Started' section with a date 'Since: 2011/09/20 10:31' and two radio buttons: 'From EPU Installation' (selected) and 'From the Last Reset'. At the bottom of the status panel, it shows 'Current CPU Power' as '29.75 Watts'. At the bottom of the main window, there is a navigation bar with buttons for 'Auto Tuning', 'Tool', 'Monitor', 'Update', 'System Information', and 'Settings'. A callout points to the 'Tool' button, stating 'Advanced settings for each mode'. Another callout points to the 'Auto Tuning' button, stating 'Displays the system properties of each mode'. A callout points to the 'VGA' icon, stating 'The items lighting up means power saving engine is activated'. A callout points to the 'Reduced CO2 Emission' value, stating 'Displays the amount of CO2 reduced'. A callout points to the radio buttons, stating '\*Shifts between the display of Total and Current CO2 reduced'. A callout points to the 'Current CPU Power' value, stating 'Displays the current CPU power'. A callout points to a small error message box in the top right corner, stating 'Displays the following message if no VGA power saving engine is detected.'



- \* Select **From EPU Installation** to show the CO2 that has been reduced since you installed EPU.
- \* Select **From the Last Reset** to show the total CO2 that has been reduced since you click the Clear button .
- Refer to the software manual in the support DVD or visit the ASUS website at [www.asus.com](http://www.asus.com) for detailed software configuration.



## 4.3.5 FAN Xpert

FAN Xpert intelligently allows you to adjust both the CPU and chassis fan speeds according to different ambient temperatures caused by different climate conditions in different geographic regions and your PC's system loading. The built-in variety of useful profiles offer flexible automatic and manual fan speed controls to achieve a quiet and cool environment.

### Launching FAN Xpert

After installing AI Suite II from the motherboard support DVD, launch FAN Xpert by clicking **Tool > FAN Xpert** on the AI Suite II main menu bar.

### Using FAN Xpert

Click **Fan Name** to select a fan and then click **Setting** to select a preset mode for your selected fan.

Click to select a fan type

Click to select a fan profile

Click to apply the settings

Click to discard the settings

Fan Power	Fan Speed
100%	N/A rpm
90%	N/A rpm
80%	N/A rpm
70%	N/A rpm
60%	N/A rpm
50%	N/A rpm
40%	N/A rpm
30%	N/A rpm
20%	N/A rpm
10%	N/A rpm
0%	N/A rpm

### Fan setting

- **Disable:** disables the **FAN Xpert** function.
- **Standard:** adjusts fan speed in a moderate pattern.
- **Silent:** minimizes fan speed for quiet fan operation.
- **Turbo:** maximizes the fan speed for the best cooling effect.
- **Intelligent:** automatically adjusts the CPU fan speed according to the ambient temperature.
- **Stable:** fixes the CPU fan speed to avoid noise caused by the unsteady fan rotation. However, the fan will speed up when the temperature exceeds 70°C.
- **User:** Allows you to configure the CPU fan profile under certain limitations.



Refer to the software manual in the support DVD or visit the ASUS website at [www.asus.com](http://www.asus.com) for detailed software configuration.

### 4.3.6 Sensor Recorder

Sensor Recorder monitors the changes in the system voltage, temperature, and fan speed on a timeline. The History Record function allows you to designate specific time spans on record to keep track of the three system statuses for certain purposes.

#### Launching Sensor Recorder

After installing AI Suite II from the motherboard support DVD, launch Sensor Recorder by clicking **Tool > Sensor Recorder** on the AI Suite II main menu bar.

#### Using Sensor Recorder

Click on **Voltage/ Temperature/ Fan Speed** tabs for the status you want to monitor. Colored lines will automatically appear on the diagram to indicate the immediate changes in the system status.

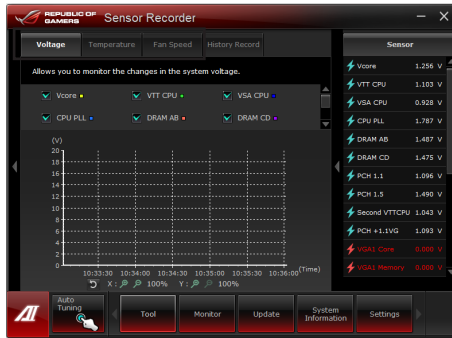

#### Using History Record

1. Click on the **History Record** tab and adjust the settings on the left for **Type**, **Date**, **Record Interval**, and **Record Duration** according to need.
2. Colored lines will then appear on the diagram to indicate the changes in the requested status of the given time.
3. Click on **Recording** to record the history changes.

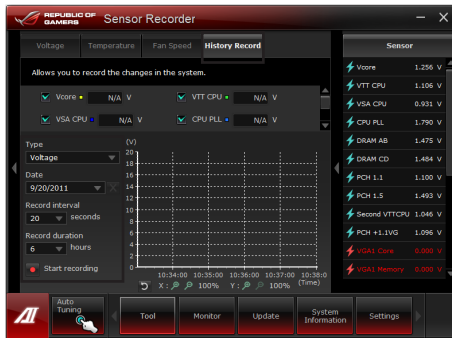

Click on **Monitor > Sensor** on the AI Suite II main menu bar and a highlight of the system statuses will appear on the right panel.

### 4.3.7 Probe II

Probe II is a utility that monitors the computer's vital components, and detects and alerts you of any problem with these components. Probe II senses fan rotations, CPU temperature, and system voltages, among others. With this utility, you are assured that your computer is always at a healthy operating condition.

#### Launching Probe II

After installing AI Suite II from the motherboard support DVD, launch Probe II by clicking **Tool > Probe II** on the AI Suite II main menu bar.

#### Configuring Probe II

Click the **Voltage/Temperature/Fan Speed** tabs to activate the sensors or to adjust the sensor threshold values. The **Preference** tab allows you to customize the time interval of sensor alerts, or change the temperature unit.



Saves your configuration

Loads your saved configuration

Loads the default threshold values for each sensor

Applies your changes



Refer to the software manual in the support DVD or visit the ASUS website at [www.asus.com](http://www.asus.com) for detailed software configuration.

### 4.3.8 USB 3.0 Boost

The ASUS exclusive USB 3.0 Boost provides speed boost for USB 3.0 devices and the up-to-date support of USB Attached SCSI Protocol (UASP). With USB 3.0 Boost, you can accelerate the transfer speed of your USB 3.0 devices with ease.

#### Launching USB 3.0 Boost

After installing AI Suite II from the motherboard support DVD, launch USB 3.0 Boost by clicking **Tool > USB 3.0 Boost** on the AI Suite II main menu bar.

#### Configuring USB 3.0 Boost

1. Connect a USB 3.0 device to the USB 3.0 port.
2. USB 3.0 Boost automatically detects the property of the connected device and switches to **Turbo** mode or **UASP** mode (if UASP is supported by the connected device).
3. You can manually switch the USB 3.0 mode back to **Normal** mode at any time.



Refer to the software manual in the support DVD or visit the ASUS website at [www.asus.com](http://www.asus.com) for detailed software configuration.

### 4.3.9 Ai Charger+

Battery Charging Version 1.1 (BC 1.1), a USB Implementers Forum (USB-IF) certified USB charging function, is designed to make USB charging faster than the standard USB devices. If your USB device supports the BC 1.1 function\*, when you connect your USB device to your system, the system automatically detects your USB device and starts a fast USB charging. The charging speed may get 3 times faster than that of the standard USB devices\*\*.



- \* Check your USB device manufacturer if it fully supports the BC 1.1 function.
- \*\* The actual charging speed may vary with your USB device's conditions.
- Ensure to remove and reconnect your USB device after enabling or disabling Ai Charger+ to ensure normal charging function.



### 4.3.10 ASUS Update

ASUS Update lays out the options for updating BIOS on your system. Update BIOS utility on your system or simply save the utility for later use just by following the directions on this convenient updating feature.

#### Launching ASUS Update

After installing AI Suite II from the motherboard support DVD, launch ASUS Update by clicking **Update> ASUS Update** on the AI Suite II main menu bar.

#### Using ASUS Update

Select the way you would like to do with the BIOS utility. Click on **Next** and follow the instructions to complete your request.

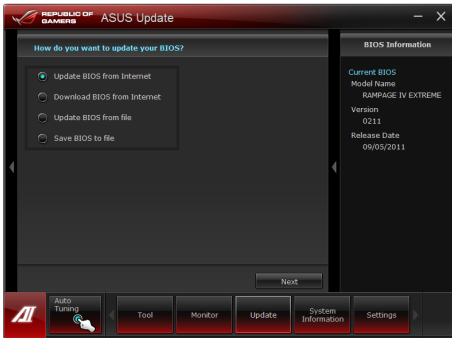

- **Update BIOS from Internet**  
Download the latest BIOS utility from the ASUS service website ([www.asus.com](http://www.asus.com)) and follow the suggested procedures to update the BIOS version on your system.
- **Download BIOS from Internet**  
Download the latest BIOS utility from the ASUS service website ([www.asus.com](http://www.asus.com)) and save for later use.
- **Update BIOS from file**  
Use the BIOS utility demanded from a source file to update the BIOS version on your system.
- **Save BIOS to file**  
Back up the current BIOS utility on your system to another file or USB disk to save for later use.



---

There may be risks of system crash when updating BIOS. Backing up the original BIOS utility is recommended before updating.

---

### 4.3.11 MyLogo2

This MyLogo utility lets you customize the boot logo. The boot logo is the image that appears on screen during the Power-On-Self-Tests (POST). Personalize your computer from the very beginning!

#### Launching ASUS Update

After installing AI Suite II from the motherboard support DVD, launch MyLogo by clicking **Update > MyLogo** on the AI Suite II main menu bar.

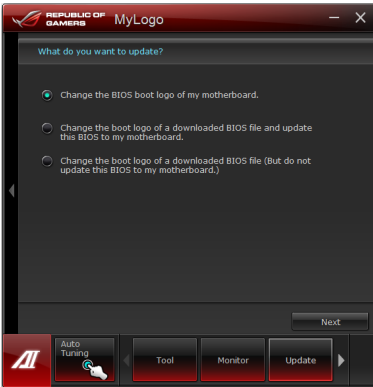

#### Using MyLogo

Select the way you would like to do update your boot logo. Then click Next and follow the given instructions.

#### Change the BIOS boot logo of my motherboard

1. Under Current BIOS, click **Browse** and choose the desired image for your boot logo. Then click on Next.

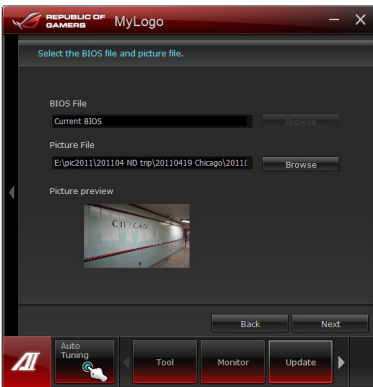

2. Click on **Auto Tune** to adjust image size compatibility or adjust the resolution bar.
3. You can click on Booting Preview to preview the boot image. Then click Next.
4. Click on Flash to start updating the image to the boot logo.
5. Click on Yes to reboot or you can also see the new logo next time you restart your computer.

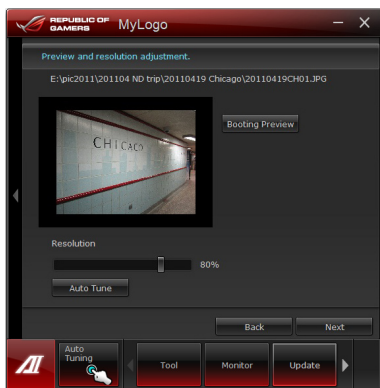

### Change the boot logo of a downloaded BIOS file and update (or do not update) this BIOS to the motherboard

1. At BIOS File, **Browse** to download the requested BIOS file to your system. This utility will help you detect the compatibility of the BIOS version.
2. Then at Picture File, Browse to select the desired image for boot logo. Click Next.
3. Follow steps 2-5 in **Change the BIOS boot logo of my motherboard** to complete logo update.

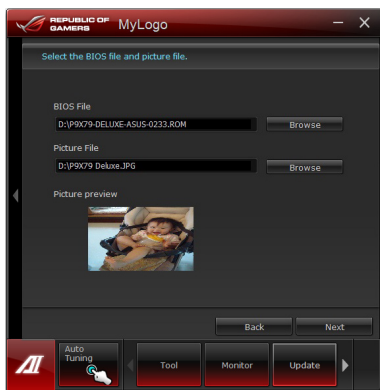

The fullscreen logo application in BIOS utility must be enabled for MyLogo to take effect.



### 4.3.12 ROG Connect

ROG Connect allows you to monitor and adjust the local PC through your remote PC.

#### Setting up USB connection between your local and remote PC



- Install **ROG Connect** on the remote PC from the provided Support DVD before using ROG Connect.
- **ROG Connect** must work with **ROG Connect Plus** to avail full function. Ensure that you install **ROG Connect Plus** on your local PC from the provided Support DVD before using **ROG Connect**.

1. Connect the provided ROG Connect cable to the local PC and the remote PC.
2. Press the ROG Connect Button and it will light up into a stable glow.
3. Double-click the **RC TweakIt** shortcut on the remote PC to activate the function

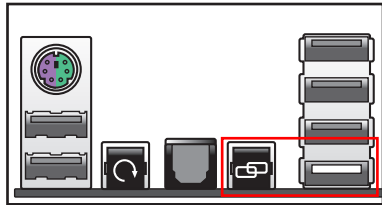

#### Using RC TweakIt

Use the sliders and buttons to monitor or adjust your local PC.

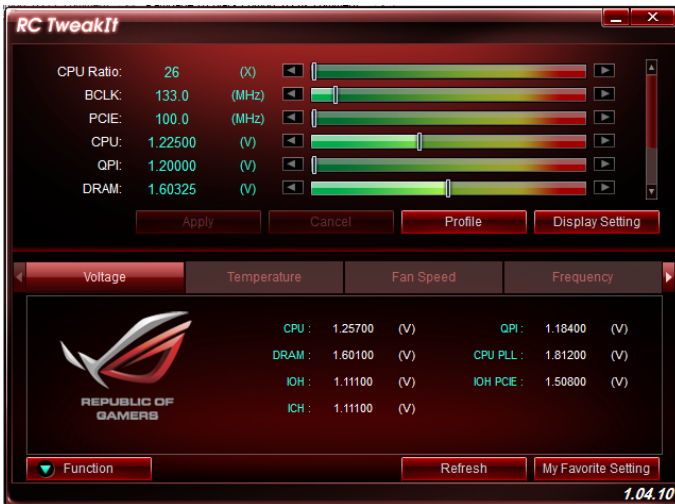

Click **Function** to display more options.



### RC Poster

RC Poster shows the status of the local system during the POST. You can switch the display mode between **String** and **Code**.

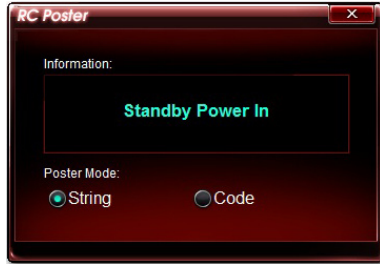

### RC Remote

RC Remote allows you to operate your local system through the ROG Connect cable.



### RC Diagram

RC Diagram allows you to monitor and record your local system status.

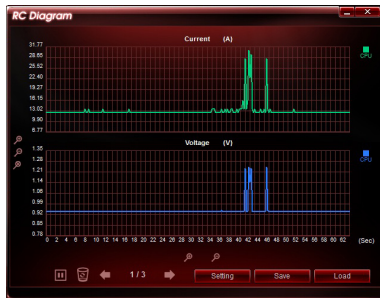

## GPU TweakIt

GPU TweakIt allows you to control and monitor the installed GPU on the local system. Use the sliders to adjust the values and click **Apply** to save your customized settings.

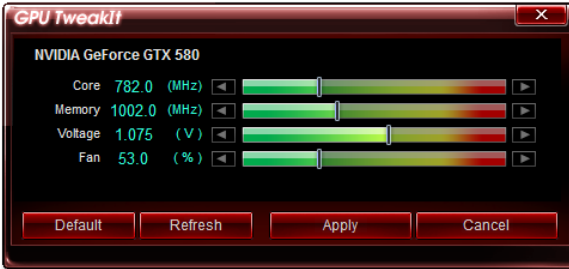

### 4.3.13 Audio configurations

The Realtek® audio CODEC provides 7.1-channel audio capability to deliver the ultimate audio experience on your computer. The software provides Jack-Detection function, S/PDIF Out support, and interrupt capability. The CODEC also includes the Realtek® proprietary UAJ® (Universal Audio Jack) technology for all audio ports, eliminating cable connection errors and giving users plug and play convenience.

Follow the installation wizard to install the Realtek® Audio Driver from the support DVD that came with the motherboard package.

If the Realtek audio software is correctly installed, you will find the **Realtek HD Audio Manager** icon on the taskbar. Double-click on the icon to display the Realtek HD Audio Manager.



Realtek HD Audio Manager

#### A. Realtek HD Audio Manager for Windows® Vista™ / 7

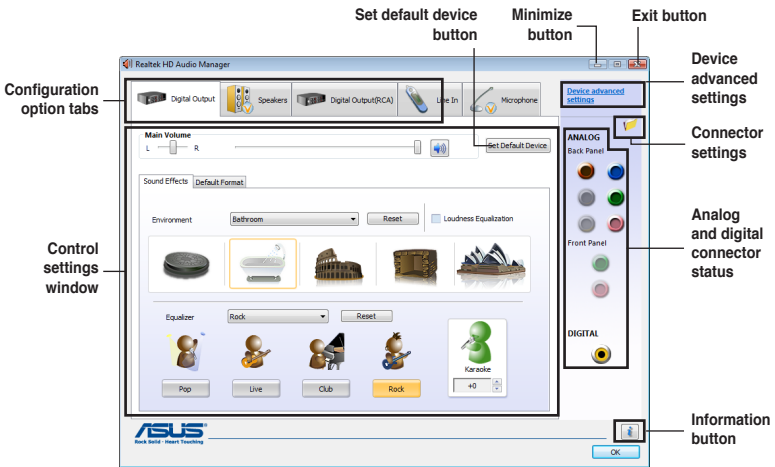

#### B. Realtek HD Audio Manager for Windows XP



Refer to the software manual in the support DVD or visit the ASUS website at [www.asus.com](http://www.asus.com) for detailed software configuration.

### 4.3.14 Sound Blaster X-Fi MB 2



This application is available only under Windows Vista and Windows 7 operating system.



This installation requires that you have the latest version of the Windows Media Player installed on your system. Ensure to download and install the latest Windows Media Player before installing Sound Blaster X-Fi MB 2.

The onboard 8-channel HD audio (High Definition Audio, previously code-named Azalia) CODEC enables high-quality 192KHz/24-bit audio output, jack-sensing feature, retasking functions and multi-streaming technology that simultaneously sends different audio streams to different destinations.

#### Activating Sound Blaster X-Fi MB 2

After installing Sound Blaster X-Fi MB 2 successfully, you need to activate this utility online before first use.

1. Double-click Activate on the desktop.



Ensure that you have successfully installed the LAN driver and have connected to the Internet.

2. Click Activate to start activation.



## Using Sound Blaster X-Fi MB 2

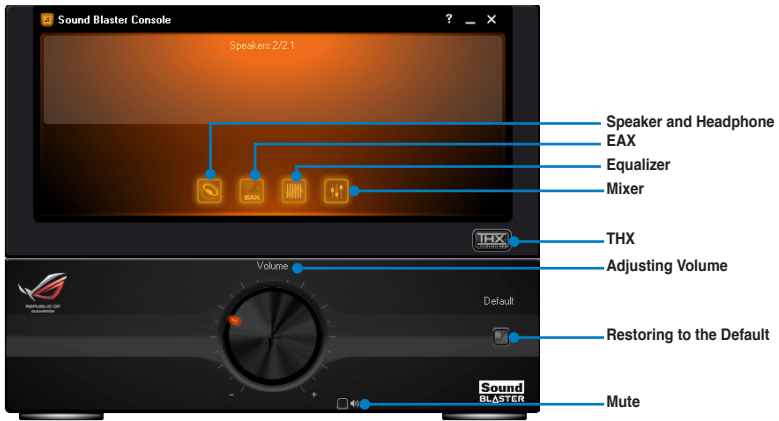

### Speaker and Headphone

You can adjust the speaker-related or the headphone-related configurations.

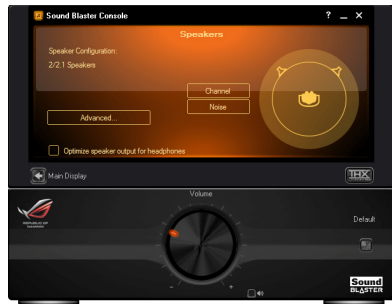

### Environment audio extensions (EAX)

After enabling the EAX effects, you are allowed to select and add your desired environment sounds into the music.

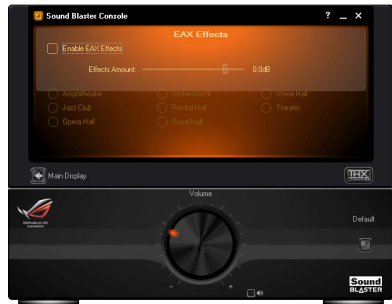

### Equalizer

You can manually adjust the audio frequency with the equalizer and customize your presets for later use.



### Mixer

You can manually adjust the audio volumes, including Line In, Stereo Mix and Microphone, when recording or during the playback.



### THX

THX is a high-fidelity sound technology that allows you to adjust the surround sound effect, sub-woofer volume, etc..



## 4.4 RAID configurations

The motherboard supports the Intel® Rapid Storage Technology with RAID 0, RAID 1, RAID 10 and RAID 5 support.



- You must install Windows® XP Service Pack 3 or later versions before using Serial ATA hard disk drives. The Serial ATA RAID feature is available only if you are using Windows® XP SP3 or later versions.
- Due to Windows® XP / Vista limitation, a RAID array with the total capacity over 2TB cannot be set as a boot disk. A RAID array over 2TB can only be set as a data disk only.
- If you want to install a Windows® operating system to a hard disk drive included in a RAID set, you have to create a RAID driver disk and load the RAID driver during OS installation. Refer to section 4.5 **Creating a RAID driver disk** for details.

### 4.4.1 RAID definitions

**RAID 0 (Data striping)** optimizes two identical hard disk drives to read and write data in parallel, interleaved stacks. Two hard disks perform the same work as a single drive but at a sustained data transfer rate, double that of a single disk alone, thus improving data access and storage. Use of two new identical hard disk drives is required for this setup.

**RAID 1 (Data mirroring)** copies and maintains an identical image of data from one drive to a second drive. If one drive fails, the disk array management software directs all applications to the surviving drive as it contains a complete copy of the data in the other drive. This RAID configuration provides data protection and increases fault tolerance to the entire system. Use two new drives or use an existing drive and a new drive for this setup. The new drive must be of the same size or larger than the existing drive.

**RAID 5** stripes both data and parity information across three or more hard disk drives. Among the advantages of RAID 5 configuration include better HDD performance, fault tolerance, and higher storage capacity. The RAID 5 configuration is best suited for transaction processing, relational database applications, enterprise resource planning, and other business systems. Use a minimum of three identical hard disk drives for this setup.

**RAID 10** is data striping and data mirroring combined without parity (redundancy data) having to be calculated and written. With the RAID 10 configuration you get all the benefits of both RAID 0 and RAID 1 configurations. Use four new hard disk drives or use an existing drive and three new drives for this setup.



## 4.4.2 Installing Serial ATA hard disks

The motherboard supports Serial ATA hard disk drives. For optimal performance, install identical drives of the same model and capacity when creating a disk array.

To install the SATA hard disks for a RAID configuration:

1. Install the SATA hard disks into the drive bays.
2. Connect the SATA signal cables.
3. Connect a SATA power cable to the power connector on each drive.

## 4.4.3 Setting the RAID item in BIOS

You must enable the RAID function in the BIOS Setup before creating RAID set(s) using SATA HDDs. To do this:

1. Enter the BIOS Setup during POST.
2. Go to the **Advanced** menu > **SATA Configuration**, and then press <Enter>.
3. Set the **SATA Mode** item to [RAID Mode].
4. Save your changes, and then exit the BIOS Setup.



Refer to Chapter 3 for details on entering and navigating through the BIOS Setup.



Due to chipset limitation, when set any of SATA ports to RAID mode, all SATA ports run at RAID mode together.

## 4.4.4 Intel® Rapid Storage Technology Option ROM utility

To enter the Intel® Rapid Storage Technology Option ROM utility:

1. Turn on the system.
2. During POST, press <Ctrl> + <I> to display the utility main menu.

```
Intel(R) Rapid Storage Technology - Option ROM - v10.0.0.1032
Copyright(C) 2003-10 Intel Corporation. All Rights Reserved.

[ MAIN MENU ]
1. Create RAID Volume
2. Delete RAID Volume
3. Reset Disks to Non-RAID
4. Recovery Volume Options
5. Exit

[ DISK/VOLUME INFORMATION ]

RAID Volumes:
None defined.

Physical Devices:
Port Device Model Serial # Size Type/Status (Vol ID)
0 ST3160812AS 9LS0HJA4 149.0GB Non-RAID Disk
1 ST3160812AS 9LS0F4HL 149.0GB Non-RAID Disk
2 ST3160812AS 3LS0JYL8 149.0GB Non-RAID Disk
3 ST3160812AS 9LS0B75H 149.0GB Non-RAID Disk

[↑↓]-Select [ESC]-Exit [ENTER]-Select Menu
```

The navigation keys at the bottom of the screen allow you to move through the menus and select the menu options.



The RAID BIOS setup screens shown in this section are for reference only and may not exactly match the items on your screen.



The utility supports maximum four hard disk drives for RAID configuration.

## Creating a RAID set

To create a RAID set:

1. From the utility main menu, select **1. Create RAID Volume** and press <Enter>. The following screen appears:

```
Intel(R) Rapid Storage Technology - Option ROM - v10.0.0.1032
Copyright(C) 2003-10 Intel Corporation. All Rights Reserved.

-----[ CREATE VOLUME MENU ]-----
Name: Volume0
RAID Level: RAID0(Stripe)
Disks: Select Disks
Strip Size: 128KB
Capacity: 0.0 GB
Sync: N/A
Create Volume

-----[ HELP ]-----

Enter a unique volume name that has no special characters and is
16 characters or less.

[↑↓]-Change [TAB]-Next [ESC]-Previous Menu [ENTER]-Select
```

2. Enter a name for the RAID set and press <Enter>.
3. When the **RAID Level** item is selected, press the up/down arrow key to select a RAID level to create, and then press <Enter>.
4. When the **Disks** item is selected, press <Enter> to select the hard disk drives you want to include in the RAID set. The **SELECT DISKS** screen appears:

```
-----[ SELECT DISKS ]-----
Port Drive Model Serial # Size Status
0 SWELL0031P2AS 9LS0BJ4Y 149.0GB Non-RAID Disk
1 ST3160812AS 9LS0F4HL 149.0GB Non-RAID Disk
2 ST3160812AS 3LS0JYL8 149.0GB Non-RAID Disk
3 ST3160812AS 9LS0BJ5H 149.0GB Non-RAID Disk

Select 2 to 6 disks to use in creating the volume.

[↑↓]-Prev/Next [SPACE]-SelectDisk [ENTER]-Done
```

5. Use the up/down arrow key to select a drive, and then press <Space> to select. A small triangle marks the selected drive. Press <Enter> after completing your selection.
6. Use the up/down arrow key to select the stripe size for the RAID array (for RAID 0, 10 and 5 only), and then press <Enter>. The available stripe size values range from 4KB to 128KB. The following are typical values:  
RAID 0: 128KB  
RAID 10: 64KB  
RAID 5: 64KB



---

We recommend a lower stripe size for server systems, and a higher stripe size for multimedia computer systems used mainly for audio and video editing.

---

7. When the **Capacity** item is selected, enter the RAID volume capacity that you want and press <Enter>. The default value indicates the maximum allowed capacity.
8. When the **Create Volume** item is selected, press <Enter>. The following warning message appears:



9. Press <Y> to create the RAID volume and return to the main menu, or <N> to go back to the **CREATE VOLUME** menu.

## Deleting a RAID set



Take caution when deleting a RAID set. You will lose all data on the hard disk drives when you delete a RAID set.

To delete a RAID set:

1. From the utility main menu, select **2. Delete RAID Volume** and press <Enter>. The following screen appears:

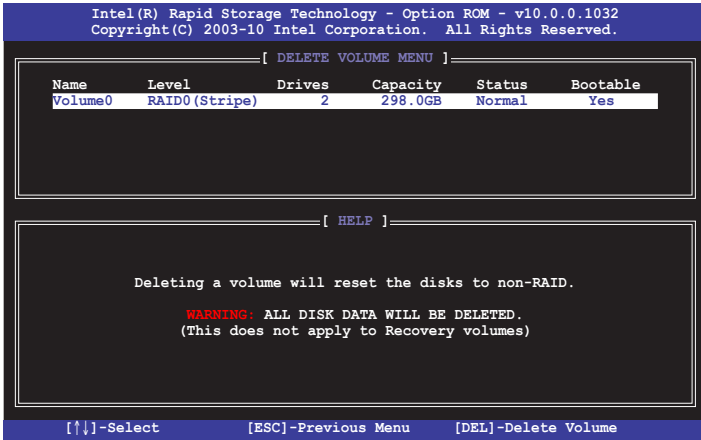

2. Use the up/down arrow key to select the RAID set you want to delete, and then press <Del>. The following warning message appears:

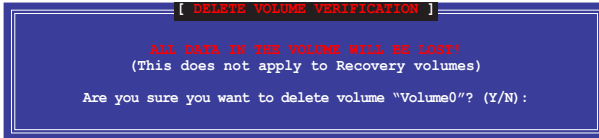

3. Press <Y> to delete the RAID set and return to the utility main menu, or press <N> to return to the **DELETE VOLUME** menu.

## Exiting the Intel® Rapid Storage Technology Option ROM utility

To exit the utility:

1. From the utility main menu, select **5. Exit**, and then press <Enter>. The following warning message appears:

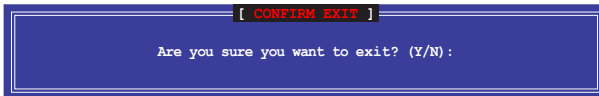

2. Press <Y> to exit or press <N> to return to the utility main menu.

## 4.5 Creating a RAID driver disk

A floppy disk with the RAID driver is required when installing a Windows® operating system on a hard disk drive that is included in a RAID set.



- **The motherboard does not provide a floppy drive connector.** You have to use a USB floppy disk drive when creating a **SATA** RAID driver disk.
- Windows® XP may not recognize the USB floppy disk drive due to Windows® XP limitation. To work around this OS limitation, refer to section **4.5.4 Using a USB floppy disk drive**.

### 4.5.1 Creating a RAID driver disk without entering the OS

To create a RAID driver disk without entering the OS:

1. Boot your computer.
2. Press <Del> during POST to enter the BIOS setup utility.
3. Set the optical drive as the primary boot device.
4. Insert the support DVD into the optical drive.
5. Save changes and exit BIOS.
6. When the **Make Disk** menu appears, press <1> to create a RAID driver disk.
7. Insert a formatted floppy disk into the USB floppy disk drive, then press <Enter>.
8. Follow the succeeding screen instructions to complete the process.

### 4.5.2 Creating a RAID driver disk in Windows®

To create a RAID driver disk in Windows®:

1. Start Windows®.
2. Plug the USB floppy disk drive and insert a floppy disk.
3. Place the motherboard support DVD into the optical drive.
4. Launch **Windows File Manager** and locate the following path in the support DVD:  
**\\Drivers\\RAID\\RSTe\\Driver**  
Double-click **AsMakeDisk.exe** to launch the **ASUS MakeDisk Utility**.
5. Select the USB floppy disk drive as the destination disk.
6. Follow the succeeding screen instructions to complete the process.



Write-protect the floppy disk to avoid a computer virus infection.

### 4.5.3 Installing the RAID driver during Windows® OS installation

To install the RAID driver in Windows® XP:

1. During the OS installation, the system prompts you to press the F6 key to install third-party SCSI or RAID driver.
2. Press <F6>, and then insert the floppy disk with RAID driver into the USB floppy disk drive.
3. When prompted to select the SCSI adapter to install, select the RAID driver for the corresponding OS version.
4. Follow the succeeding screen instructions to complete the installation.

To install the RAID driver for Windows® Vista or later OS:

1. During the OS installation, click **Load Driver** to allow you to select the installation media containing the RAID driver.
2. Insert the USB flash drive with RAID driver into the USB port or the support DVD into the optical drive, and then click **Browse**.
3. Click the name of the device you've inserted, go to **Drivers > RAID**, and then select the RAID driver for the corresponding OS version. Click **OK**.
4. Follow the succeeding screen instructions to complete the installation.



---

Before loading the RAID driver from a USB flash drive, you have to use another computer to copy the RAID driver from the support DVD to the USB flash drive.

---

## 4.5.4 Using a USB floppy disk drive

Due to OS limitation, Windows® XP may not recognize the USB floppy disk drive when you install the RAID driver from a floppy disk during the OS installation.

To solve this issue, add the USB floppy disk drive's Vendor ID (VID) and Product ID (PID) to the floppy disk containing the RAID driver. Refer to the steps below:

1. Using another computer, plug the USB floppy disk drive, and insert the floppy disk containing the RAID driver.
2. Right-click **My Computer** on the Windows® desktop or **start** menu, and then select **Manage** from the pop-up window.

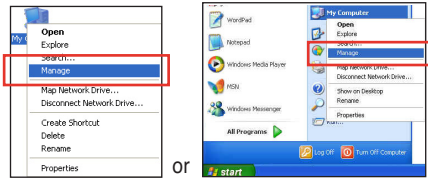

3. Select **Device Manager**. From the **Universal Serial Bus controllers**, right-click **xxxxxx USB Floppy**, and then select **Properties** from the pop-up window.



The name of the USB floppy disk drive varies with different vendors.

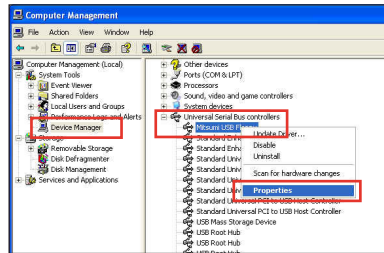

4. Click **Details** tab. The Vendor ID (VID) and Product ID (PID) are displayed.

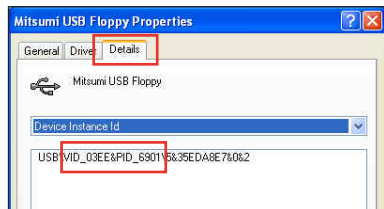

5. Browse the contents of the RAID driver disk to locate the file **txtsetup.oem**.
6. Double-click the file. A window appears, allowing you to select the program for opening the oem file.

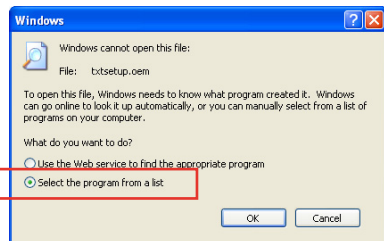

7. Use Notepad to open the file.

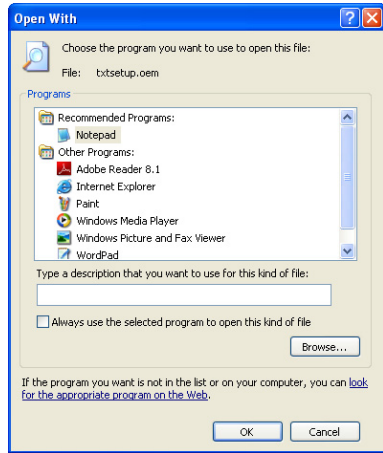

8. Find the [HardwareIds.scsi.iaAHCI\_DesktopWorkstationServer] and [HardwareIds.scsi.iaStor\_DesktopWorkstationServer] sections in the txtsetup.oem file.
9. Type the following line to the bottom of the two sections:
- id = "USB\VID\_03EE&PID\_6901", "usbstor"**

```
[HardwareIds.scsi.iaAHCI_DesktopWorkstationServer]
id= "PCI\VEN_8086&DEV_1C02&CC_0106", "iaStor"
id= "USB\VID_03EE&PID_6901", "usbstor"

[HardwareIds.scsi.iaStor_DesktopWorkstationServer]
id= "PCI\VEN_8086&DEV_2822&CC_0104", "iaStor"
id= "USB\VID_03EE&PID_6901", "usbstor"
```



\_\_\_\_\_

Add the same line to both sections.

\_\_\_\_\_



\_\_\_\_\_

The VID and PID vary with different vendors.

\_\_\_\_\_

10. Save and exit the file.



# Chapter 5

## 5.1 AMD® CrossFireX™ technology

The motherboard supports the AMD® CrossFireX™ technology that allows you to install multi-graphics processing units (GPU) graphics cards. Follow the installation procedures in this section.

### 5.1.1 Requirements

- In Dual CrossFireX mode, you should have two identical CrossFireX-ready graphics cards or one CrossFireX-ready dual-GPU graphics card that are AMD® certified.
- Ensure that your graphics card driver supports the AMD CrossFireX technology. Download the latest driver from the AMD website ([www.amd.com](http://www.amd.com)).
- Ensure that your power supply unit (PSU) can provide at least the minimum power required by your system. See Chapter 2 for details.



- 
- We recommend that you install additional chassis fans for better thermal environment.
  - Visit the AMD Game website (<http://game.amd.com>) for the latest certified graphics card and the supported 3D application list.
- 

### 5.1.2 Before you begin

For AMD CrossFireX to work properly, you have to uninstall all existing graphics card drivers before installing AMD CrossFireX graphics cards to your system.

To uninstall existing graphics card drivers:

1. Close all current applications.
2. For Windows XP, go to **Control Panel > Add/Remove Programs**.  
For Windows Vista, go to **Control Panel > Programs and Features**.
3. Select your current graphics card driver/s.
4. For Windows XP, select **Add/Remove**.  
For Windows Vista, select **Uninstall**.
5. Turn off your computer.

### 5.1.3 Installing two CrossFire™ graphics cards



The following pictures are for reference only. The graphics cards and the motherboard layout may vary with models, but the installation steps remain the same.

1. Prepare two CrossFireX-ready graphics cards.
2. Insert the two graphics card into the PCIEX16 slots. If your motherboard has more than two PCIEX16 slots, refer to Chapter 2 in this user manual for the locations of the PCIEX16 slots recommended for multi-graphics card installation.
3. Ensure that the cards are properly seated on the slots.
4. Align and firmly insert the CrossFireX bridge connector to the goldfingers on each graphics card. Ensure that the connector is firmly in place.

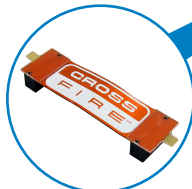
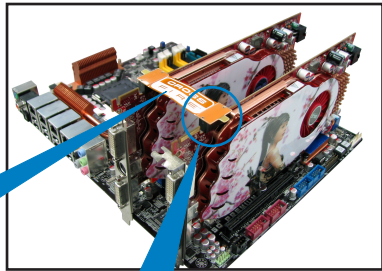
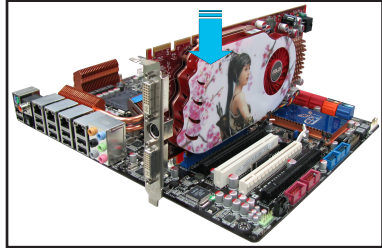

CrossFireX bridge  
(bundled with  
graphics cards)

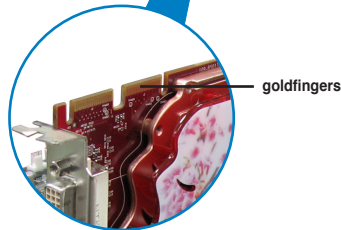

5. Connect two independent auxiliary power sources from the power supply to the two graphics cards separately.
6. Connect a VGA or a DVI cable to the graphics card.

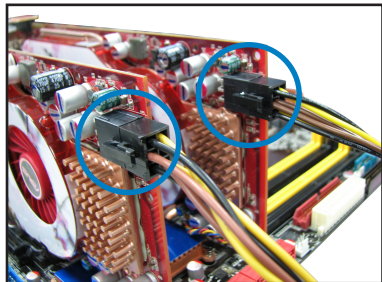

### 5.1.4 Installing the device drivers

Refer to the documentation that came with your graphics card package to install the device drivers.



Ensure that your PCI Express graphics card driver supports the AMD® CrossFireX™ technology. Download the latest driver from the AMD website ([www.amd.com](http://www.amd.com)).

### 5.1.5 Enabling the AMD® CrossFireX™ technology

After installing your graphics cards and the device drivers, enable the CrossFireX™ feature through the AMD Catalyst™ Control Center in Windows environment.

#### Launching the AMD VISION Engine Control Center

To launch the AMD VISION Engine Control Center:

1. Right-click on the Windows® desktop and select **AMD VISION Engine Control Center**. You can also right-click the AMD icon in the Windows notification area and select **Vision Engine Control Center**.

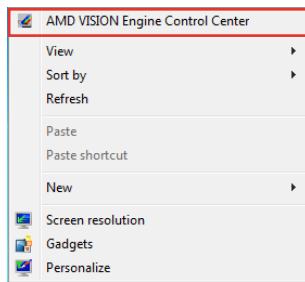

2. The **VISION Engine Control Center Setup Assistant** appears when the system detects the existence of multi-graphics cards. Click **Go** to continue to the **VISION Engine Control Center Advanced View** window.

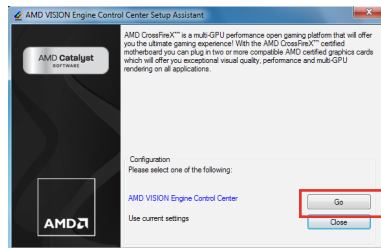

#### Enabling Dual CrossFireX technology

1. In the Catalyst Control Center window, click **Graphics Settings > Performance > AMD CrossFireX™ Configuration**.
2. From the Graphics Adapter list, select the graphics card to act as the display GPU.
3. Select **Enable CrossFireX™**.
4. Click **Apply**, and then click **OK** to exit the window.

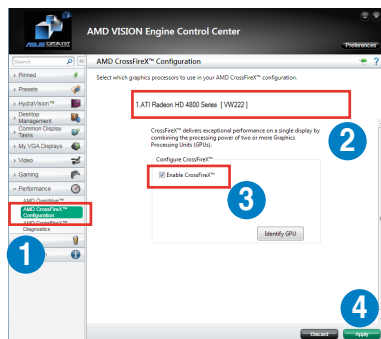

## 5.2 NVIDIA® SLI™ technology

The motherboard supports the NVIDIA® SLI™ (Scalable Link Interface) technology that allows you to install multi-graphics processing units (GPU) graphics cards. Follow the installation procedures in this section.

### 5.2.1 Requirements

- In SLI mode, you should have two identical SLI-ready graphics cards that are NVIDIA® certified.
- Ensure that your graphics card driver supports the NVIDIA SLI technology. Download the latest driver from the NVIDIA website ([www.nvidia.com](http://www.nvidia.com)).
- Ensure that your power supply unit (PSU) can provide at least the minimum power required by your system. See Chapter 2 for details.



- We recommend that you install additional chassis fans for better thermal environment.
- Visit the NVIDIA zone website (<http://www.nzone.com>) for the latest certified graphics card and supported 3D application list.

### 5.2.2 Installing two SLI-ready graphics cards



The following pictures are for reference only. The graphics cards and the motherboard layout may vary with models, but the installation steps remain the same.

1. Prepare two SLI-ready graphics cards.
2. Insert the two graphics card into the PCIEX16 slots. If your motherboard has more than two PCIEX16 slots, refer to Chapter 2 in this user manual for the locations of the PCIEX16 slots recommended for multi-graphics card installation.
3. Ensure that the cards are properly seated on the slots.

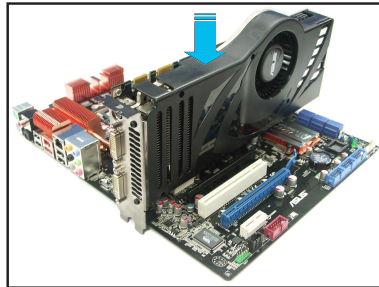

4. Align and firmly insert the SLI bridge connector to the goldfingers on each graphics card. Ensure that the connector is firmly in place.
5. Connect two independent auxiliary power sources from the power supply to the two graphics cards separately.
6. Connect a VGA or a DVI cable to the graphics card.

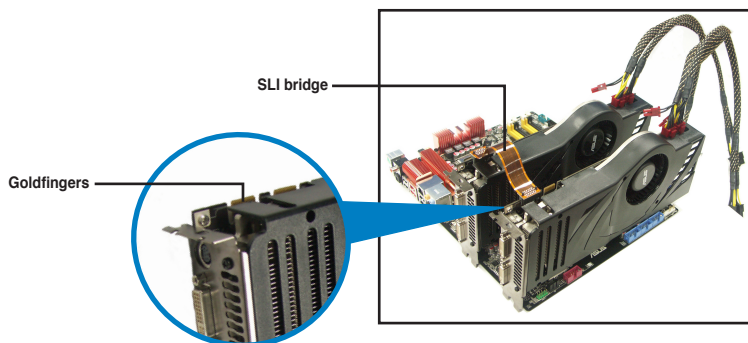

### 5.2.3 Installing the device drivers

Refer to the documentation that came with your graphics card package to install the device drivers.



Ensure that your PCI Express graphics card driver supports the NVIDIA® SLI™ technology. Download the latest driver from the NVIDIA website ([www.nvidia.com](http://www.nvidia.com)).

### 5.2.4 Enabling the NVIDIA® SLI™ technology

After installing your graphics cards and the device drivers, enable the SLI feature in NVIDIA® Control Panel under the Windows® Vista™ operating system.

#### Launching the NVIDIA Control Panel

You can launch the NVIDIA Control Panel by the following two methods.

- A. Right click on the empty space of the Windows® desktop and select **NVIDIA Control Panel**.  
The NVIDIA Control Panel window appears (See Step B5).

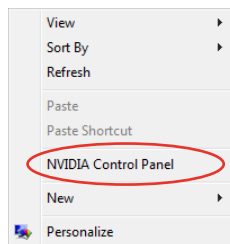

- B1. If you cannot see the NVIDIA Control Panel item in step (A), select **Personalize**.

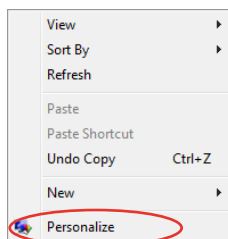

- B2. From the **Personalization** window, select **Display Settings**.

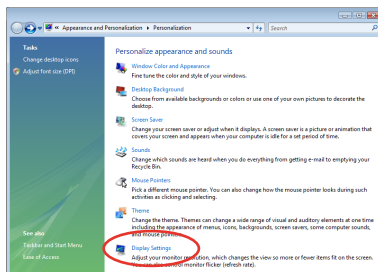

- B3. From the Display Settings dialog box, click **Advanced Settings**.

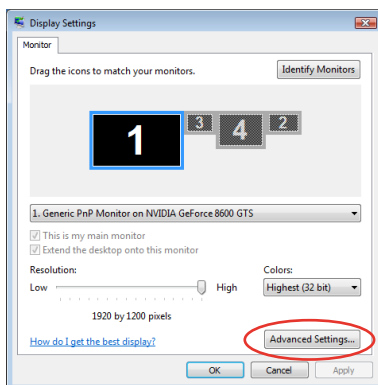

- B4. Select the NVIDIA GeForce tab, and then click **Start the NVIDIA Control Panel**.

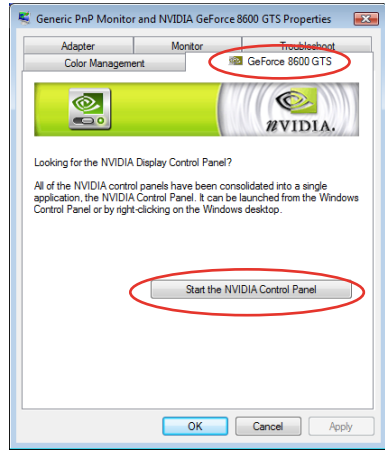

- B5. The NVIDIA Control Panel window appears.

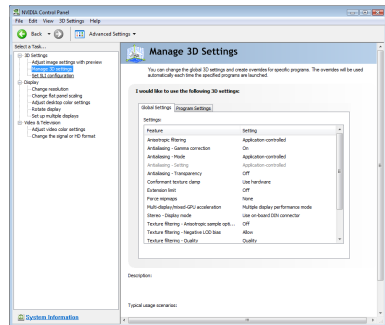

## Enabling SLI settings

From the NVIDIA Control Panel window, select **Set SLI Configuration**. Click **Enable SLI** and set the display for viewing SLI rendered content. When done, click **Apply**.

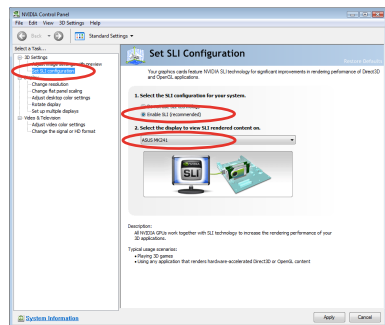





## **ASUS contact information**

### **ASUSTeK COMPUTER INC.**

Address	15 Li-Te Road, Peitou, Taipei, Taiwan 11259
Telephone	+886-2-2894-3447
Fax	+886-2-2890-7798
E-mail	info@asus.com.tw
Web site	www.asus.com.tw

#### ***Technical Support***

Telephone	+86-21-38429911
Online support	support.asus.com

### **ASUS COMPUTER INTERNATIONAL (America)**

Address	800 Corporate Way, Fremont, CA 94539, USA
Telephone	+1-812-282-3777
Fax	+1-510-608-4555
Web site	usa.asus.com

#### ***Technical Support***

Telephone	+1-812-282-2787
Support fax	+1-812-284-0883
Online support	support.asus.com

### **ASUS COMPUTER GmbH (Germany and Austria)**

Address	Harkort Str. 21-23, D-40880 Ratingen, Germany
Fax	+49-2102-959911
Web site	www.asus.de
Online contact	www.asus.de/sales

#### ***Technical Support***

Telephone (Component)	+49-1805-010923*
Telephone (System/Note/Eee/LCD)	+49-1805-010920*
Support Fax	+49-2102-9599-11
Online support	support.asus.com

\* EUR 0.14/minute from a German fixed landline; EUR 0.42/minute from a mobile phone.

# DECLARATION OF CONFORMITY

Per FCC Part 2 Section 2.1.1077(e)



Responsible Party Name: **Asus Computer International**

Address: **800 Corporate Way, Fremont, CA 94539.**

Phone/Fax No: **(510)739-3777/(510)608-4555**

hereby declares that the product

**Product Name : Motherboard**

**Model Number : Rampage IV Formula**

Conforms to the following specifications:

- FCC Part 15, Subpart B, Unintentional Radiators
- FCC Part 15, Subpart C, Intentional Radiators
- FCC Part 15, Subpart E, Intentional Radiators

### Supplementary Information:

This device complies with part 15 of the FCC Rules. Operation is subject to the following two conditions: (1) This device may not cause harmful interference, and (2) this device must accept any interference received, including interference that may cause undesired operation.

Representative Person's Name : Steve Chang / President

Signature : 

Date : Oct. 31, 2011

Ver. 110101

# EC Declaration of Conformity



We, the undersigned,

Manufacturer: **ASUSTEK COMPUTER INC.**  
Address: City: **No. 150, LI-TE RD., PEITOU, TAIPEI 112, TAIWAN R.O.C.**  
Country: **TAIWAN**  
Authorized representative in Europe: **ASUS COMPUTER GmbH**  
Address: City: **HARKORT STR. 21-23, 40880 RATINGEN**  
Country: **GERMANY**

declare the following apparatus:

Product name : **Motherboard**  
Model name : **RAMPAGE IV FORMULA**

conform with the essential requirements of the following directives:

**2004/108/EC-EMC Directive**  
 EN 55022:2006+A1:2007  EN 55024:1998+A1:2001+A2:2003  
 EN 61000-3-2:2006+A1:2009+A2:2009  EN 61000-3-3:2008  
 EN 55013:2001+A1:2003+A2:2006  EN 55022:2007

**1989/5/EEC-R & TTE Directive**

EN 300 328 V1.7 (2006-09)  
 EN 300 440-2 V1.2 (2008-03)  
 EN 300 446-2 V1.2 (2008-03)  
 EN 301 511 V9.0.2(2003-03)  
 EN 301 808-1 V3.2.1 (2007-05)  
 EN 301 885 V1.2 (2006-05)  
 EN 301 893 V1.2 (2006-03)  
 EN 302 544-2 V1.1.1 (2009-01)  
 EN 50360:2001  
 EN 50371:2002  
 EN 50385:2002

EN 301 488-1 V1.8.1 (2008-04)  
 EN 301 489-1 V1.3.1 (2005-08)  
 EN 301 489-4 V1.3.1 (2006-08)  
 EN 301 489-7 V1.3.1 (2005-11)  
 EN 301 489-9 V1.4.1 (2007-11)  
 EN 301 489-10 V1.1 (2007-06)  
 EN 301 489-11 V1.1 (2007-06)  
 EN 301 489-14 V1.1 (2007-06)  
 EN 302 326-2 V1.2 (2007-06)  
 EN 302 326-3 V1.3.1 (2007-06)  
 EN 301 357-2 V1.3.1 (2006-05)  
 EN 302 623 V1.1.1 (2009-01)

**2009/95/EC-LVD Directive**

EN 60950-1:2006  
 EN 60950-1:2006+A1:2009  
 EN 60065:2002+A1:2006+A11:2008

**2009/125/EC-ERP Directive**

Regulation (EC) No. 1275/2006  
 EN 62301:2005  
Regulation (EC) No. 642/2009  
 EN 62301:2005

Regulation (EC) No. 279/2009  
 EN 62301:2005

Ver. 110101



(EC conformity marking)

Position : **CEO**  
Name : **Jerry Shen**



Signature : \_\_\_\_\_

Declaration Date: **Oct. 31, 2011**

Year to begin affixing CE marking: **2011**